



SECURITY MANUFACTURING CORPORATION

AskYourLocksmith.com
Lancaster, Pennsylvania
Phone 717-392-6333

HERTY GERTY TUBULAR KEY MACHINE



AIHG-1

731⁵⁰

Duplicate tubular keys without having to make a large investment. Extremely easy to operate: Decode the original key with the supplied decoder and place the blank on the index hub. Dial the desired cut-depth, turn the hand crank, and you've made your tubular key. In just seconds, this extraordinary equipment will cut #137 tubular keys — Ace standard, small (137S), large (137A, UL), offset right and left; in addition to Gem, Taylor, and others with spacing anywhere from 0° to 360°
Supplied complete with decoder, special high speed steel cutters and complete instructions in a convenient wooden case.

EJECTOR PUNCHES

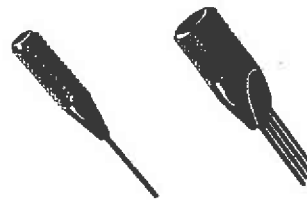

Two tools for ejecting IC cores.

TBIP - Originally designed for use with THE BLOCK, this punch is suitable for most any I/C core.

TBMP - Use this time saving 4 pronged punch to eject cores. Suitable for manual use and with A-1's service equipment. Ejects cores with two hits instead of 6 or 7.

AITBIP
21⁹⁰

AITBMP
38⁰⁰

COMPLETE SERVICE KIT FOR I/CORE

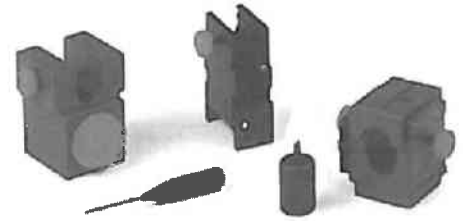

Includes A1 tools

- TB1** Decoding Block
- TB2** Multi-Use Capping Block
- TB3** Dumping Block

AIHCKT
420⁰⁰

If purchased separately, a combined price of 427.70.

Buy as a kit and save 32.70

CAPPING PRESS

Caps and dumps IC cores. The only capping press which also dumps cores, this machine costs about half as much as many less versatile capping presses.

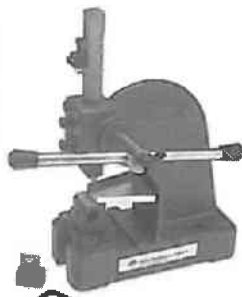

AI CAP-1
990⁰⁰

- AI40A** Accessory Top **85.00**
- AI40B** Accessory Kit for .140 spacing **151.00**

PLUG SPINNER



AI26
69⁹⁰

This tool is a must when it's easier to pick a lock backwards instead of in the right direction. With the lock picked in the direction, simply wind the spinner in the proper direction, set the trigger, insert the blade into the plug and then release the trigger. The plug is now picked in the right direction.

THE BLOCK

An interchangeable core hold fixture, designed to service Best/Falcon type systems with a maximum of seven pins. Compact and rugged mechanism for getting foolproof answers when looking for control-key codes. It's easy-to-use; just drive the pin stacks into the Block where the pin tray area keeps them separated. Works better than shimmying or hand disassembly because, when opened, all pin stacks are accessible yet secure. Made of anodized aircraft alloy.

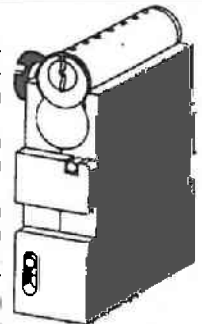

AITB1
170⁰⁰

CAPPING BLOCK

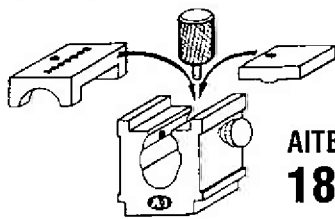

AITB2
180⁰⁰

Designed to save you space, time and money, TB2 is more than just a capping block. It is a versatile and compact workstation for interchangeable cores that's lie having two capping blocks in one unit. Made with hard anodized aircraft alloy and heat-treated steel, it comes with two different tops which allows it to cap Best, Eagle, Arrow and Falcon cores.

DUMPING BLOCK



AITB3
110⁰⁰

Dumps and holds pins and springs from dozens of cores made by Best, Eagle, Arrow and Falcon. Using the standard ejector pin (included), simply drive the pin stacks into the lower compartment until they are ready to be disposed. Hardcoat anodized aluminum construction.

DUO BLOCK

Can be used for both .140 and .150 spacing. Ideal for capping Best® type cylinders and KABA Peaks®. Caps both standard and spring (slide covered) I/cores.

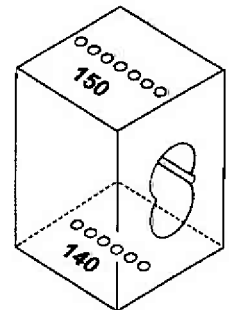

AITB4
145⁰⁰



MORTISE CYLINDER FORCE TOOL



Applies over 150 ft. lbs of torque to overcome set screws on most mortise cylinders. Designed to defeat any mortise lock, including shrouded and internally staked locks. Uses standard drill bit and wrench.

AI61 139.00

FEATHER TOUCH TENSION WRENCH

Light turning pressure. Automatically adjusts to the proper tension.



AI11 37⁹⁰

A1 MAGNUM PICK GUN



Features easy tension adjustment. Three tips and a tension wrench are included. The pick gun can be easily disassembled for maintenance.

AI44 51⁵⁰ AI44-REPL Replacement picks 9.50

BROKEN KEY PULLERS - SET OF 3

Designed to be the most effective extractors available today. Made of top American steel, the blades are locked in steel and fitted with a comfortable handle. Include three extractor types; .040 spiral, saw tooth, and hook.

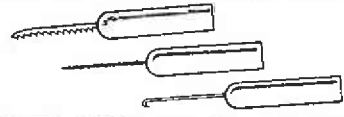

INCLUDES A 5-YEAR WARRANTY

Code	Description	Price
AI27	1 ea spiral saw tooth, hook	33.00
AI27-SP	3 spirals	33.00
AI27-HK	3 hooks	33.00
AI27-ST	3 saw teeth	33.00

TENSION WRENCH SET

Two tension wrenches, one medium, one heavy duty.

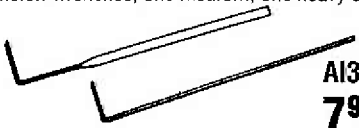

AI32 7⁹⁰

LOCKSMITH TWEEZER

5" long, this tweezer features grooved tips for fast and easy loading of cylinder pins.

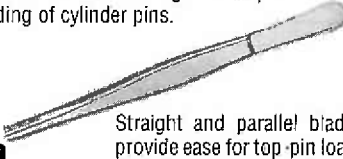

AI29 31⁹⁰ Straight and parallel blades provide ease for top-pin loading.

QUICKPULL

Cylinder Removal Tool For Kwikset and Dexter Developed specially for locksmiths, this innovative tool removes cylinders from Kwikset 400 series and Dexter 3200 series knob locks without causing any damage. Quickly snaps cylinders from the front of these popular key-in knob locksets. No need for Knob disassembly. No need to remove interior knob. Note: Dexter 3200 series will require replacement of retainer clips.

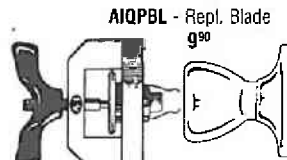

AIQP 159⁰⁰ AIQPBL - Repl. Blade 9⁹⁰

MASTER LOCKSMITH HAMMER

At last, a light weight (2 oz.) hammer just for locksmiths. Features a head with one end brass, the other end durable non-marring plastic.



AI28 39⁰⁰

THE WAFFLE PINNING TRAY

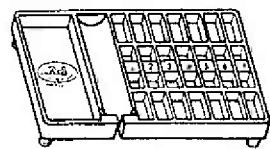

AIWT1 43⁰⁰

A compact and stackable tray that neatly separates pins, springs and plugs in numbered pockets. Useful for rekeying operations. Provides efficient use of workspace. Made of high quality plated metal.

DELUXE OPENING KIT

This complete set comes with a top quality, zippered Condura nylon case, which has additional room for other small tools.



AI25 COMES WITH A PLUG SPINNER! 79⁰⁰

RETAINING RING PLIERS

Unique ergonomic design allows a natural hand-wrist orientation, which reduces fatigue. A1's innovative tool features integral rings for working internal or external rings, return spring and cushioned grips for your comfort.



AI42 39⁰⁰

SHIM HOLDER WITH 25 SHIMS

Holds curved shims firm, straight and without slippage to prevent accidental finger cuts and ease operations. Tap small end on hard surface, then insert shim to desired length. Press down on large end and shim is tight. Comes with 25 top-quality shims.



AI18 33⁰⁰ Curved Shims
AI19 6.50(pkg of 25)

SECURITY MULTI-DRIVER

Includes the following security bits:

- Torx 9, 10
- Hex 3/16, 5/32, 1/8, 9/64
- Spanner 4, 6, 8, 10
- Phillips #2
- Slotted 7/32

Bits are made of S2 hardened steel. The handle features a 1/4" nut driver and a patented end cap that keeps your stored bits secure.

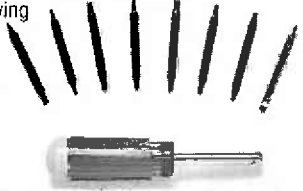

AI41 63.90

BROKEN EXTRACTOR KIT

High performance broken-key puller set in a genuine leather case. Contains one each of hook, standard spiral, large spiral and saw-tooth pullers.

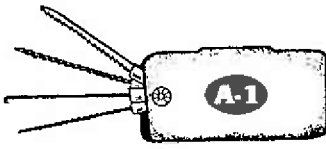

AIKP1 39⁹⁰



SECURITY MANUFACTURING CORPORATION

AskYourLocksmith.com
Lancaster, Pennsylvania
Phone 717-392-6333

TUBULAR LOCK SAW

Saw cut away the shoulder over the pins allowing them to be removed so lock can be opened. Pins remain intact for decoding. Also saws locks with ball bearings in the key way. Not for use on hardened locks or locks with deadpins.



AI14
71⁹⁰

TUBULAR LOCK A-PICK

Made of heat-treated stainless steel, this versatile pick can open 137 standard tubular locks with mushroom pins, passing all dead pins. Comes with decoder.



Code	Description	Price
AI20	A-Pick-Center)	145.00
AI20-SET	A-Pick-Center/Offset	319.00
AI20-X	A-Pick Offset	185.00

GENERAL MOTORS LOCK DECODER

This quality type tool makes everyone a professional from the start. Decode all year General Motors sidebar locks without complete disassembly. This unique tool works when all others fail. Comes with easy-to-understand instructions. One locksmith writes, "I think G.M. Decoder is the best tool I have used to decode the wafers. Thanks."

AI6
71⁹⁰



VULCAN BUTTON GRABBER

Open up a whole new world by owning this unique design car opener. The rubber loop grabs and holds most buttons, even straight ones. Insert through the jam, use strings to align over button, pull band tight and up, bingo you're in! Even works on autos with vacuum systems such as Mercedes. **No wedge required • Won't scratch vehicle • No damage to in-door wiring or linkage • Guided by direct eyesight.**

AI02
31⁹⁰

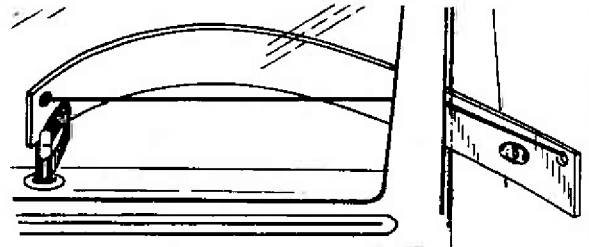

QUICKPULL 2 FOR SCHLAGE 'F' SERIES

Similar to the original, and extremely popular Quickpull for Kwikset knob sets, this new tool removes knobs for Schlage 'F' series. Using the additional tools included, replacement of the original knob & cylinder can be accomplished quickly and effortlessly, saving valuable time on the job. Knobs can be removed from the exterior and replaced in just minutes.

AIQP-2
179⁹⁰



CYLINDER REMOVAL TOOL

This cam action tool is the best design we have found to remove stubborn mortise cylinders. This heavy-duty tool automatically adjusts from 15/16" to 1 1/2" in diameter.

AI16
77⁹⁰



THE A1 FIGHTING WEDGE

Fortified, inflatable wedge can exert extreme pressure to widen the gap with your favorite car opening tools. Use for safes, window and door installations, too.

AI43
51⁵⁰



BROKEN KEY PULLERS

Get-A-Grip Key Puller: A hexagonal handle and large .040 spiral offer superior ability to extract broken keys AI30 7.44

Mega Grip Key Puller: Exceptionally large .074 spiral is great for use on many imported autos. AI30B 9.00

Get-A-Grip Set: 2 each of A1's popular Get-A-Grip and Mega Grip Key Pullers in 1 convenient set. AI30-SET 35.90



SPINNAKUR PLUG SPINNER

TWO YEAR LIMITED WARRANTY. Made of durable materials, this tool will offer years of reliable service. Features space-age spring mechanism, push-button release, left or right rotation, streamlined design. Weighs only 2 1/4" oz. and will fit in shirt pocket and many pick kits.

AI5P1
79⁹⁰





**PAK - A - PUNCH™
 KEY-PUNCH FOR INTERCHANGEABLE CORE**

- Another Innovative product from A-1
- Code cuts A2, A3, A4 "Best" type keys from factory code or from A-1's decoder
- A-1 Decoder **INCLUDED**
- Includes high impact plastic **CARRYING CASE**
- Affordable Pricing
- Precise cuts every time
- Hand operated - Great for mobile shops
- Will give years of reliable service

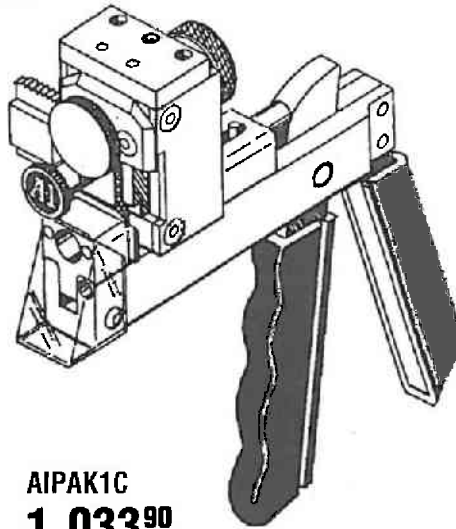

**AIPAK1C
 1,033⁹⁰**

The PAK-A-PUNCH™ is precision engineered to manufacturer's specifications. All working and wearing parts are replaceable. A-1 will provide a factory recondition program which will replace all wearing parts, and readjust to original specifications.

**INTERCHANGEABLE
 CORE KEY DECODER**

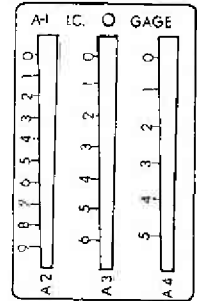

**A14
 35⁰⁰**

**PAK - A - PUNCH™ MODEL 3
 KEY-PUNCH**

- Another Innovative product from A-1
- Optional **CARRYING CASE**
- Affordable Pricing
- Precise cuts every time
- Hand operated - Great for mobile shops
- Will give years of reliable service



The PAK-A-PUNCH™ is precision engineered to manufacturer's specifications. All working and wearing parts are replaceable. A-1 will provide a factory recondition program which will replace all wearing parts, and readjust to original specifications.

OPTIONS:

AIPK-CS2	Large Case	119.00
AIPK-CSE	Small Case	67.00

AIPAK-3K	Kwikset	919.90
AIPAK-3S	Schlage	900.00
AIPAK-3T	Auto, Schlage	758.00
	Kwikset, I/Core	

(Adapter paks required)

QUICKCHANGE KITS

MANUF	KEY BLANK	KIT	PRICE
Chrysler	Y-149, Y-152 Y-153	AIPAK-C1	175.00
Chrysler	Y-155, Y-156 Y-157	AIPAK-C2	175.00
Chrysler	Y-154	AIPAK-C3	175.00
Ford	H-54, H-55 H-56, H-60 H-62	AIPAK-F1	175.00
Ford	H-50, H-51 H-52, H-53	AIPAK-F4	199.00
GM	A, B, C, D, E	AIPAK-G1	199.00
GM	H, J, K, B-83	AIPAK-G2	175.00
J Series	B-68, B-84	AIPAK-G11	175.00
GM(Saturn)	B-76		

Other adapters available. Call with your requirements.



SECURITY MANUFACTURING CORPORATION

AskYourLocksmith.com
Lancaster, Pennsylvania
Phone 717-392-6333

• MORTISE JIGS • TOOLS

GM 10-CUT COLUMN MOUNTED PICKS & DECODER

Includes specialized tension tools & rocker picks, release tool (releases cylinder from column), and decoder. Complete the job in 3/5 minutes.

AIPS2
295⁰⁰

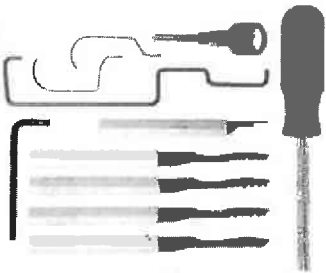

GM 10-CUT IN DASH - THE 7 MINUTE ALTERNATIVE

Thanks to A-1, you'll tackle this job in 5/7 minutes. Includes bezel and face cap removal tool, specialized tension tools & rocker picks, release tool, decoder and jig.

AIPS3
295⁰⁰

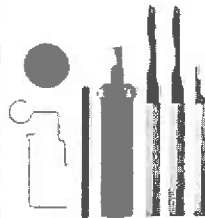

FORD 8-CUT PICK SET

A-1's newest automotive pickset is the professional choice for servicing these ignitions.

Simply remove the bezel with the bezel removal tool; use the jig and bit to drill a .070 pilot hole; insert the tension tool; pick the lock. Once complete, replace the lock and the bezel.

AIPS4
249⁰⁰

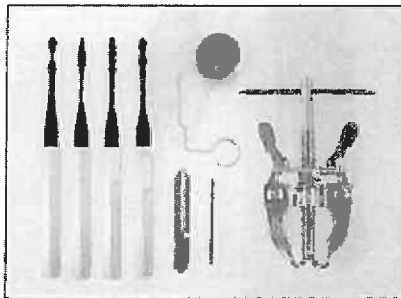

PICK SET FOR CHRYSLER

Everything needed to reliably pick Chrysler ignitions. Use the hook to remove the faceplate. Use our drill guide and bit to drill 3/32 sidebar pilot. Insert tension tool and pick. Place new face cap onto ignition and crimp with capping tool.

AIPS5
275⁰⁰

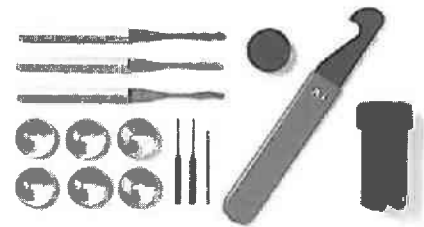

K100 KELLY KLAMP

Need a third hand for installing overhead magnets? A1 has the answer.

The Kelly Klamp, magnetic installation tool.

AIK100
149⁰⁰

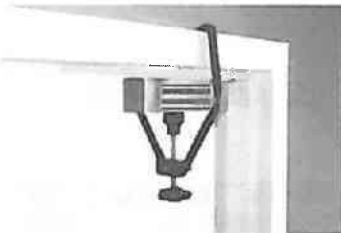

J-50 INSTALLATION JIG FOR SIMPLEX 1000

Greatly simplifies installation of the Simplex 1000 series of locks. Just clamp the fixture to the correct location and begin drilling. There is no marking, no pilot holes, no more guesswork, no more destroyed doors.

AIJ-50
310⁰⁰

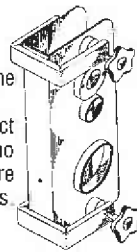

J-55 INSTALLATION JIG FOR TRILOGY

Greatly simplifies installation of the Alarm Lock Trilogy series of locks. Just clamp the fixture to the correct location and begin drilling. There is no marking, no pilot holes, no more guesswork, no more destroyed doors.

AIJ-55
310⁰⁰

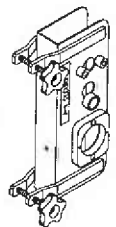

M100 MORTISE LOCK & CROSSHOLE INSTALLATION KIT

A-1's M-100 is the ideal tool for complete mortise lock installation. Use the M-100 to prepare the mortise cavity and faceplate pocket then use the optional side-plates for crossbore holes. The M-100 Mortiser is self centering and has a clamping range on doors from 1" to 2 1/2". The backset is instantly adjustable for 2 3/4", 2 1/2", and 2 3/8" without the need for additional hand tools. Includes specialized bits for drilling 1" mortise cavity and 1 1/4" faceplate pocket. Additional mortising bits available in sizes 7/8" and 3/4". Use the M-100 as a stand alone Mortiser or add the optional pairs of side plates to prep doors for cross holes.

AIM100
1,390⁰⁰

Optional Side Plates

- AIM1** Arrow Mortise 369.90
- AIM2** Marks Mortise 399.90
- AIM3** Baldwin Mortise 299.90
- AIM4** Schlage 'L' Mortise 329.90
- AIM5** Simplex/Trilogy 353.90
- AIM6** Corbin/Ruswin 353.90
- AIM7** Sargent 353.90

AIM120 Carrying Case for M100 55.00

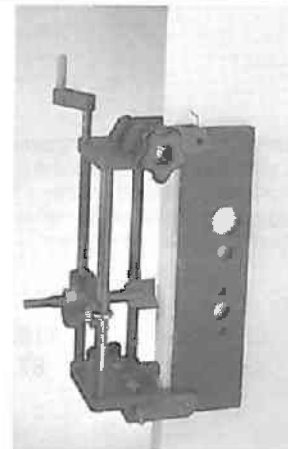



ADJUSTABLE TENSION WRENCH

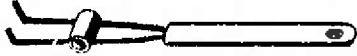

Appropriate for use on auto locks with spring-loaded dust covers. Designed for picking double-bitted locks (Schlage wafer, Chicago, Junkunc), but also works well with pin-tumbler locks, even the Yale #8. Spring steel fingers adjust from 5/16" to 5/8" and are held at the desired width by an adjustable collar.

A124
41⁹⁰

12 PIECE PICK SET 45

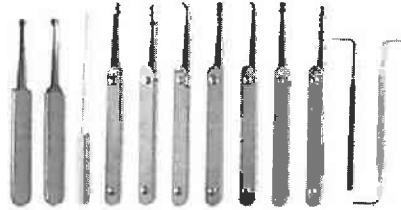

Set of 9 picks (7 with stainless steel handles), 2 tension wrenches and a Get-A-Grip spiral key extractor in a handsome leather case.

9 picks
 2 tension wrenches
 1 key extractor

A145
60⁰⁰

STAMPING PLATE

Stamp keys and I/Cores with this A-1 stamping fixture. Manufactured of Delrin so keys won't jump around while stamping. Will hold other blanks, including: Schlage, Corbin/Russwin, etc.

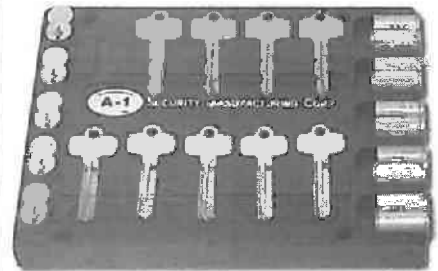

A135
279⁰⁰

DECODER FOR G.M. 10-CUT



Use for decoding G.M. 10-cut ignitions.

A131
31⁰⁰

ACE KEY DECODER

Decodes Tubular Keys
 Quickly and Accurately



A152
8⁵⁰

CAPSAVER™ PRESS FOR INTERCHANGEABLE CORE

The most time consuming task of capping cores is placing the small caps onto each chamber of the core. With the CapSaver™ Press, A-1's exclusive CapSaver™ strips will replace traditional caps. The CapSaver™ press actually punches and forms the caps as it seats them into the core.

Users will realize a considerable amount of direct savings in both time and materials. Actual tests demonstrate that 30 seconds is saved just in the time spent loading the 6 or 7 caps before staking them.

Each CapSaver™ strip is designed to cap four 6 or 7 pin cores and costs users about half as much as the caps produced by a leading manufacturer (suggested dealer price).

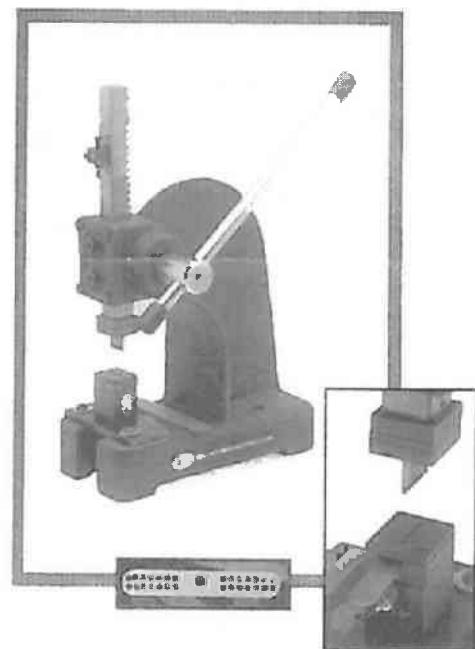

AICAP-5	CapSaver™ Press for I/Core	1395.00
AICS-50	CapSaver™ Strips - 50 count	51.00
AICS-250	CapSaver™ Strips - 250 count	231.90



SECURITY MANUFACTURING CORPORATION

AskYourLocksmith.com
Lancaster, Pennsylvania
Phone 717-392-6333

BUL-1 BULLS EYE INSTALLATION TOOL FOR CYLINDRICAL LOCKSETS

Use this tool when locating and drilling crossbore and latch hole when installing cylindrical locks. Economically designed for locksmiths, this new tool is equipped to drill 1 1/2" and 2 1/8" cross bores and includes an automatic adjustment that requires no additional tools.

**AIBUL-2
425⁶⁰**

Optional straps available to put two BUL-2's together for installing interconnected locks or dual bores. Adjustable from 3" - 6" on center and are marked with 1/4" increments. **AIBULL-SS2**



CABINET LOCK INSTALLATION JIG

Bulls Eye installation for cabinet locks, including I/Core. Manufactured of aircraft grade aluminum alloy and steel bushings, this jig is designed to install two styles of cabinet locks. Includes two bushings for 3/4" and 1 1/8"-1 1/4" camlocks.

**AIBUL-1
269⁹⁰**

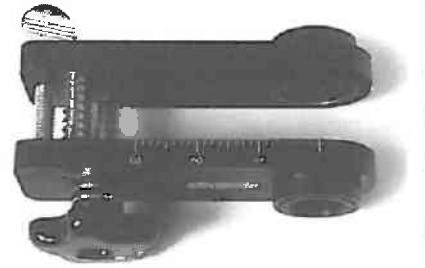

MEAN GREEN MACHINE

Absolutely the Best Piece of Equipment Ever Designed for Originating Small Format I/Core Keys. The Mean Green Machine is Fast, Accurate and Durable.

The Mean Green Machine features interchangeable vises allowing you to quickly switch punching capability from SFIC to other specialty keyways. You'll love the way the side mounted depth knob and automatic key advance speed up the cutting process without mis-cuts. Manufactured with cast iron and brass, A1's Mean Green Machine is built to last.



**AIGP201-A2 For System A2
3,390⁰⁰**

**AIGP201-A3 For System A3
3,390⁰⁰**

**AIGP201-A4 For System A4
3,390⁰⁰**

**AIGP201-FA2 For Arrow Flexcore
3,390⁰⁰**

- Interchangeable Vise
- Large 180° Depth Knob
- Durable - Built to Last
- Automatic Key Advance

Built in USA by A-1 Security Manufacturing

Accessory Flexcore Vise For the Mean Green Machine



This accessory vise allows you to quickly switch punching capabilities of the Mean Green Machine from SFIC to Flexcore.

**AIGPF-024
370⁰⁰**

Chrysler Keyblanks



AIY160S-PT Transponder 28.20

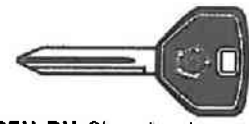

AIY157PEN-PH Chrysler Logo 1.98

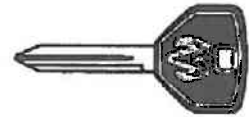

AIY157RAM-PHRam Logo 1.98

8-CUT IGNITION LOCK

















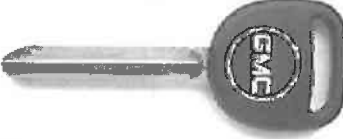

Fits Many Models 1997-2007

AILC6941 Coded 33.90

AILC6941U Uncoded 27.00



AUTOMOTIVE KEYBLANKS

<p>FORD</p> <p>Ford 10-Cut Keyblank</p>  <p>AIH67-PF Ford Logo 1.40</p> <p>Ford 8-Cut Keyblank</p>  <p>AIH75-PF Ford Logo 1.80</p>	<p>Buick LeSabre/Rendezvous 2000 & Up Transponder PK3+ (B99) with Buick logo.</p>  <p>AIGMX-220 28.20</p> <p>Pontiac Bonneville/Aztec 2000 & Up Transponder PK3+ (B99) with Pontiac logo.</p>  <p>AIGMX-310 28.20</p> <p>Chevrolet Colorado Original blank with the Chevrolet Bowtie logo.</p>  <p>AI16652 1.98</p> <p>GMC Canyon (B110) Original blank with GMC logo.</p>  <p>AI16653 1.98</p>	<p>SOMERSET BRAND TRANSPONDERS</p> <p>Ford 8-cut PATS Transponder</p>  <p>AIS-72 17.00</p> <p>Ford Focus/Escape Transponder</p>  <p>AIS-86 23.60</p> <p>Toyota Transponder</p>  <p>AITOY43-AT4 34.30</p> <p>Nissan Transponder</p>  <p>AIN102T 30.80</p> <p>GM Large Head Transponder</p>  <p>AIB99S-PT 24.16 AIB99-GPT GM OEM Logo 18.80</p> <p>GM Small Head Transponder</p>  <p>AIB97S-PT 22.50 AIB97-GPT GM OEM Logo 20.30</p>  <p>AIB103GPT PK3 88 GRV 20.30</p> <p>Honda Transponder</p>  <p>AIHD106PT 21.00</p>
<p>GM Cadillac CTS Transponder PK3+ with Cadillac logo that is on-board programmable.</p>  <p>AIGMX-320 44.00</p> <p>Cadillac 2004 SRX Transponder PK3+ with Cadillac logo that is on-board programmable.</p>  <p>AIGMT-265 44.00</p> <p>Pontiac Grand Prix Transponder PK3+ with Pontiac logo that is on-board programmable.</p>  <p>AIGMX-367 39.00</p> <p>Chevrolet Malibu 2004 Transponder PK3+ with Chevrolet logo that is on-board programmable.</p>  <p>AIGMX-380 39.00</p>	<p>GM PINNING KITS</p> <p>GM 'Z' Keyway Combination Pin-Kit Includes tumblers and springs for all locks used in 2004+ Malibu, Grand Prix, SRX and more. AI20001 339.00</p> <p>GM Pin-Kit, 'H' Cars Includes tumblers, ignition retainers and springs for all locks used in LeSabre, Bonneville, Aurora and CTS. AI20005 70.00</p> <p>Pin-Kit, Colorado/Canyon Includes all tumblers and springs used in Chevrolet Colorado and GMC Canyon. AI20020 63.50</p>	