

Postal locks have been approved by the Manufacturers of USPS Postal Equipment.

PTR-656UN



Package contents: 1 lock (non-dust shuttered) with 2 keys, 5 OHE replacement cams, 2 different gauge mounting clips.

ESPTR-656UN5
12⁴⁰

PTR-DC656UN



Package contents: 1 lock (dust shuttered) with 2 keys, 5 OEM replacement cams, 2 different gauge mounting clips with a hex nut.

ESPTR-DC656UN5
12⁸⁰

PT812RN5CPA



HL1 (Hudson Lock Replacement), .812 cylinder length **THREADED**, 7/8" face diameter, 5 OEM replacement cams, 2 nickel plated keys, Hudson Keyway. Ideal for high security applications with oversized door thickness. Mount with hex nut included.

ESPT812RN5CPA
12⁸⁰

PUSH BUTTON FILE CABINET LOCKS

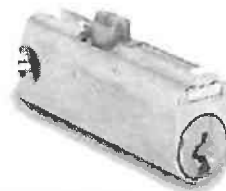

PTR-1750S312
Machine Screw Mounting
1 3/4" Replacement for HON
ESPTR-1750S312 13.00

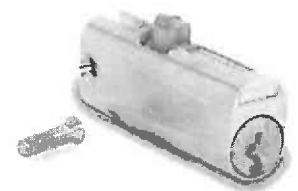

PTR-1750S500
Machine Screw Mounting
1 3/4" Replacement for
Anderson Hickey.
ESPTR-1750S500 13.00

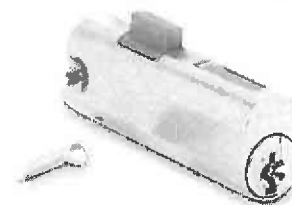

PTR-2000S344
Machine Screw Mounting
1 3/4" Replacement for HON
ESPTR-2000S344 14.20

- LOCKS
- DISPLAYBOARD
- Drawer
- Desk

AMES DOOR & LOCK SUPPORT

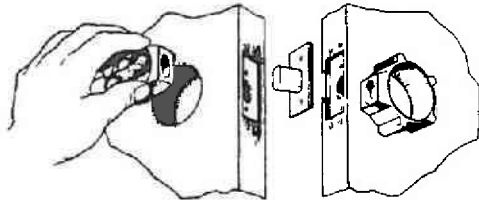

Now you can firmly anchor deadbolts and knob locks in hollow metal door!

Here's the answer you've been locking for to completely eliminate all collapsing and loosening problems when installing locks on hollow metal doors! The Ames Door & Lock Support is 1 5/8" wide, flexible and adjustable thus assuring use for any locks requiring 2-1/8", 1-5/8" or 1-1/2" cross bores.

ESA1346
13.20

Some of the popular style locks the Ames Door & Lock Support can be used with include:

- | | | |
|----------------|----------------|-----------------------|
| <i>Schlage</i> | <i>Sargent</i> | <i>Corbin/Russwin</i> |
| <i>Schlage</i> | <i>Weslock</i> | <i>Medeco</i> |
| <i>Russwin</i> | <i>Weiser</i> | <i>Kwikset</i> |
| <i>Dexter</i> | | |

WOOD DESK LOCKS

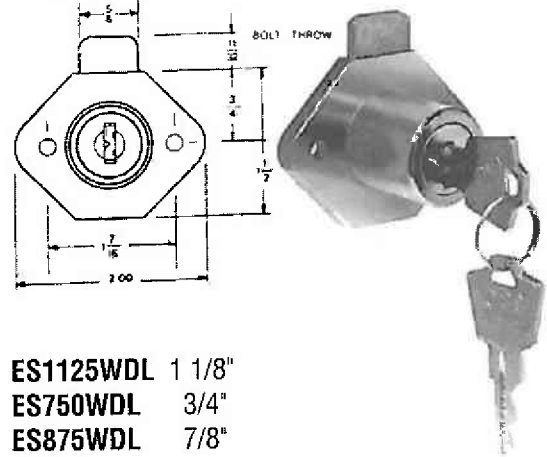

ES1125WDL 1 1/8"
ES750WDL 3/4"
ES875WDL 7/8"
6⁸⁰

Available keyed alike, keyed different, and master keyed; the 875WDL, 750WDL, AND 1125WDL can be ordered with the same key changes as ESP Camlocks. Packaged complete with 2 mounting wood screws in a clear poly bag, 12 locks per carton.

OPERATION: Key turns 180° clockwise, moving steel bolt upwards. Key removable in both locked and unlocked position. Available in Brass finish, includes 2 brass key (ES8).

AMARLITE REPLACEMENT LOCK

This lock is the only exact replacement for the original Amarlite Telescopic Bolt Lock that can be purchased as a regular stock item on a continual basis. Manufactured to the exact specifications of the Original Amarlite Lock, it allows for a rapid installation and eliminates all need for additional difficult and time consuming alterations to the door.

Locks supplied less cylinders. Cylinder holes are threaded for the Original Amarlite cylinder as well as any standard size mortise cylinders.

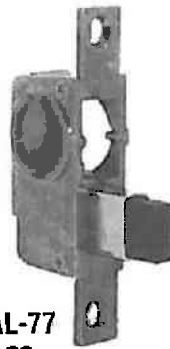

ESAL-77
43⁰⁰

FLUSH MOUNT PLUNGER MOUNT

Replaces Hudson G2139, National C8042. Bright Nickel Finish



NO. 1030FM
FLUSH MOUNT

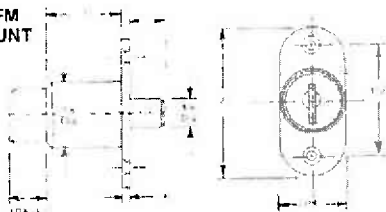

ES1030FM
16⁵⁰
 12/box

Bright Brass Finish

METAL DRAWER LOCK

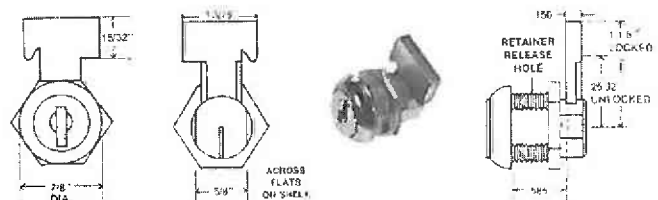

EST585
9⁰⁰
 12/box

Available keyed alike, keyed different, and master keyed; the T585 can be ordered with the same key changes as ESP Camlocks and Wood Desk locks. Packaged 12 locks per carton. Uses ES-8 Keyway, 2 key per lock.

OPERATION: Key turns 180° clockwise moving T-bolt upwards. Key removable in both locked and unlocked position.



SLIDING DOOR RATCHET LOCK

NO. 8RL — Adjustable clamp on ratchet bar enables lock to be used on doors up to 11/16" thick, can be used on glass, wood or metal doors. Packaging includes, one lock and one ratchet bar per box.

NO. 7RL — Ideal security for all sliding glass doors, book cases, display cases, etc. For doors up to 1/4" thick. Packaging includes, one lock and one ratchet bar per box.

NO. 15RL — Universal package includes one lock, one 8RL and one 7RL ratchet bar per box.

OPERATION — To lock, slide ratchet bar through lock. To unlock, turn key 90° and remove ratchet bar from lock.

KEYING — Available keyed alike, keyed different.

Masterkeying available on special order basis. Two brass keys, ESP furnished, with each lock.

STOCK FINISH — Bright Nickel.

ES8RL	Doors Up to 11/16" Thick	9.40
ES7RL	Doors Up to 1/4" Thick	9.40
ES15RL	Package of Two Ratchets and One Lock	12.60

HIDE-A-KEY

It's the "Original" - magnetic key holder known the world over! Made in the U.S.A., the original Hide-A-Key features the extra powerful, double size magnet not found on other domestic and imported brands.

Don't settle for anything less than the original Hide-A-Key! Available in three styles.

Our popular self-selling point-of-purchase display.

This attractive 11-1/4" x 14-1/8" metal display stand comes with one dozen Hide-A-Keys magnetically attached.

ESHAK-1
35⁷⁰



HIDE-A-KEY PLUS

An all new version of the original classic! The HIDE-A-KEY PLUS is larger to hold today's bigger, longer keys. Made of specially developed rugged plastic, it features strong double magnets for extra powerful gripping strength to do the job other can't do.

Comes on a colorful 11 1/4" x 14 1/8" metal display stand. 10 pieces per stand.

ESHKP-21
51¹⁰



SPRING WIRE ASSORTMENT



ESSWA-100
32²⁰ ea.

The SWA-100 is a spring wire assortment which features the most popular sizes of round spring wire used in making springs for various mortise locks and other security products.

The SWA-100 is packed in a durable plastic see-through tube for easy handling and storage, and includes 15 pieces each of the 7 most popular thicknesses of spring wire, all 12" in length.

CAMLOCK REKEYING KIT

Here's no frills kit that give you exactly what you need to rekey camlocks-namely, WAFER TUMBLERS and SPRINGS! We've eliminated unnecessary parts that clutter up your work area. You get exactly what you need, nothing more, nothing less! Used in rekeying 90% of the wafer camlocks in the market place, the CRK-30 features a portable, spill proof, durable vinyl case that fits snugly in your shirt pockets.



ESCRK-30
38⁷⁰

•CAM LOCKS

VISUAL PACK CAM LOCKS



6⁸⁰ ea.

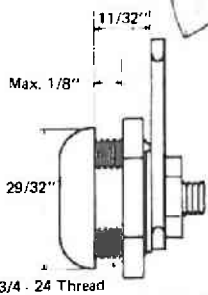

ESULR344STD 11/32"

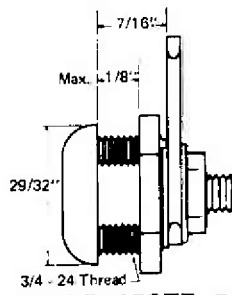

ESULR437STD 7/16"

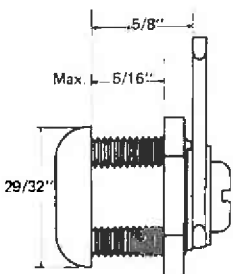

ESULR625STD 5/8"

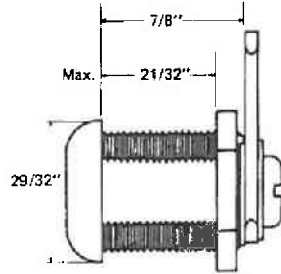

ESULR875STD 7/8"

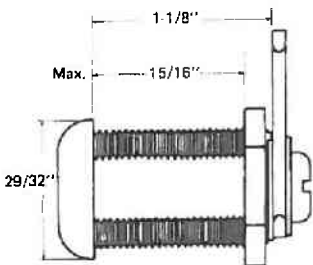

ESULR1125STD 1 1/8"

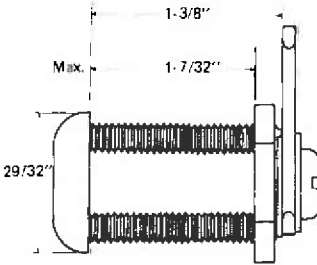

ESULR1375STD 1 3/8"

Note: 437, 625, 875, 1125, and 1375 Camlocks available with dust cover. Specify "DC" after item number.

STOCK CUSTOM PACKAGED CAM LOCKS FOR IMMEDIATE DELIVERY!

Here are the six popular sized cam locks, packaged in an attractive see-thru poly bag—just the way your customers purchase them.

PARTS:

All six sizes of locks furnished with the following:

Part No.	Description
ESP-8	Brass Key Blanks (2)
ULP-09	180° stop
ULP-09L	90° Stop
ULP-08	Locking Nut
ULP-6A	1/8" Stainless Steel Cylinder Ring
ULP-07	Spur Washer
ULC-93/090	Straight Cam
ULC-93/464	Offset Cam
ULP-11	Sem Screw

FUNCTIONS:

Threaded shells are available as follows:

- A. 4 spline-key removable in locked and unlocked position with 90° or 180° Stop.
- B. 2 spline - key removable in locked and unlocked position with 180° Stop.
- C. 2 spline - key removable in locked position only with 90° Stop.

KEYING:

100 Key changes regularly furnished - keyed alike, keyed different or keyed alike in groups. Master-Keying also available. Additional key changes available-specify quantity and needs for quotation.

KEYWAY:

ESP keyway conforms with keyways of Chicago, Yale, Hurd, All Lock, Fort Lock, Old Ico, and Hudson.

KEYS:

Two brass keys (ES8) furnished with each lock, except ULR344STD, furnished with an ES84 keyblank.

HOW TO ORDER:

Cam Locks regularly packaged with 4 spline threaded shell. If two spline shell required, please specify as following example:

USR625STD x 2 spline shell.

FALCON®

AskYourLocksmith.com
Lancaster, Pennsylvania
Phone 717-392-6333

•LOCKSET

X SERIES HEAVY DUTY LOCKS

2 3/4" backset. For doors 1 3/4" to 2" thick by adjustment of the threaded rose collars. Cylinders are drilled with 6-pin chambers; but pinned in 5. Reversible handing. Latches have 9/16" bolt projection and are UL listed. Standard latch faceplates are 2 1/4" x 1 1/8" with square corners. Standard strike measures 2 3/4" x 1 1/8" with a curved lip 1 5/16" lip-to-center. Furnished with Phillips flat head wood screws (7" x 3/4") and Phillips flat head machines screws (8-32 x 3/8") for latch and strike attachment on metal and/or wood doors and frames. ANSI Grade 1. Packed 20/case.

PASSAGE

Latch bolt by knobs.

Code	Finish	Price
FAX101EG-605	Bright Brass	258.00
FAX101EG-612	Satin Bronze	243.00
FAX101EG-626	Satin Chrome	243.00
FAX101HG-605	Bright Brass	258.00
FAX101HG-612	Satin Bronze	243.00
FAX101HG-626	Satin Chrome	243.00
FAX101TG-605	Bright Brass	258.00
FAX101TG-612	Satin Bronze	243.00
FAX101TG-626	Satin Chrome	243.00

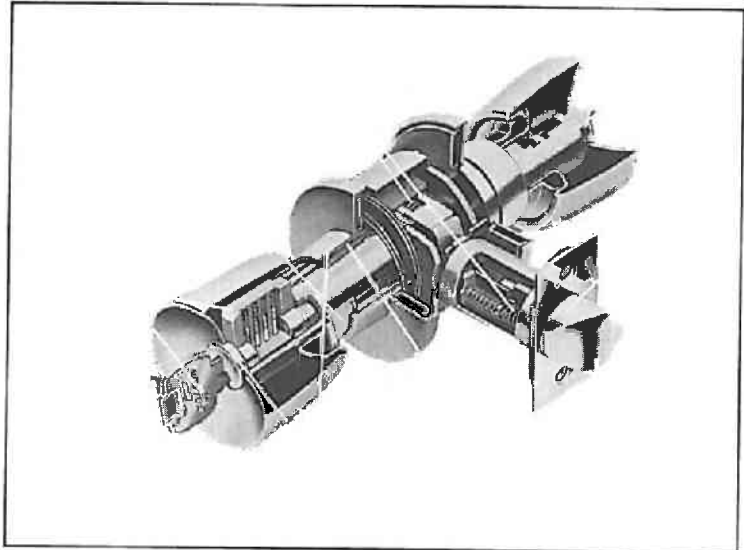

ALSO AVAILABLE IN IC CORE (exc. Hana)

PRIVACY

Latch bolt by knobs except when outside knob is locked by push bottom in inside knob. Rotating inside knob or closing door releases button. Emergency release in outside knob.

Code	Finish	Price
FAX301EG-605	Bright Brass	316.00
FAX301EG-612	Satin Bronze	302.00
FAX301EG-626	Satin Chrome	302.00
FAX301HG-605	Bright Brass	316.00
FAX301HG-612	Satin Bronze	302.00
FAX301HG-626	Satin Chrome	302.00
FAX301TG-605	Bright Brass	316.00
FAX301TG-612	Satin Bronze	302.00
FAX301TG-626	Satin Chrome	302.00

ENTRANCE/OFFICE

Latch bolt by knob from either side, except when the outside knob is locked by inside knob button. Inside knob always free.

Code	Finish	Price
FAX511EG-605	Bright Brass	355.00
FAX511EG-612	Satin Bronze	340.00
FAX511EG-626	Satin Chrome	340.00
FAX511HG-605	Bright Brass	355.00
FAX511HG-612	Satin Bronze	340.00
FAX511HG-626	Satin Chrome	340.00
FAX511TG-605	Bright Brass	355.00
FAX511TG-612	Satin Bronze	340.00
FAX511TG-626	Satin Chrome	340.00

ASYLUM

Deadlocking latch bolt by knobs, except when either knob is locked by key in its own cylinder.

Code	Finish	Price
FAX411EG-605	Bright Brass	412.00
FAX411EG-612	Satin Bronze	396.00
FAX411EG-626	Satin Chrome	396.00
FAX411HG-605	Bright Brass	412.00
FAX411HG-612	Satin Bronze	396.00
FAX411HG-626	Satin Chrome	396.00
FAX411TG-605	Bright Brass	412.00
FAX411TG-612	Satin Bronze	396.00
FAX411TG-626	Satin Chrome	396.00

CLASSROOM

Deadlocking latch bolt by knobs, except when outside knob is locked by key in outside knob.

Code	Finish	Price
FAX561EG-605	Bright Brass	355.00
FAX561EG-612	Satin Bronze	340.00
FAX561EG-626	Satin Chrome	340.00
FAX561HG-605	Bright Brass	355.00
FAX561HG-612	Satin Bronze	340.00
FAX561HG-626	Satin Chrome	340.00
FAX561TG-605	Bright Brass	355.00
FAX561TG-612	Satin Bronze	340.00
FAX561TG-626	Satin Chrome	340.00

STOREROOM

Deadlocking latch bolt by inside knob or key outside. Outside knob rigid.

Code	Finish	Price
FAX581EG-605	Bright Brass	355.00
FAX581EG-612	Satin Bronze	340.00
FAX581EG-626	Satin Chrome	340.00
FAX581HG-605	Bright Brass	355.00
FAX581HG-612	Satin Bronze	340.00
FAX581HG-626	Satin Chrome	340.00
FAX581TG-605	Bright Brass	355.00
FAX581TG-612	Satin Bronze	340.00
FAX581TG-626	Satin Chrome	340.00

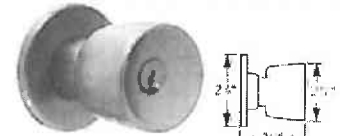

EG
Elegance

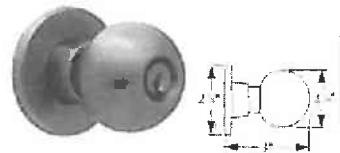

HG
Hana

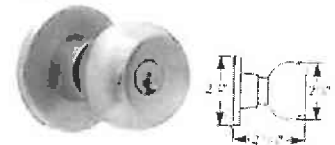

TG
Terra

•LOCKSETS

T SERIES EXTRA HEAVY DUTY LOCK GRADE 1 KEY-IN-LEVER w/CLUTCH

- PressureRelease levers. Locked levers disengage when excess pressure is applied. Prevents damage to lock mechanism.
- Meet new ANSI A156.2 - Series 4000, Grade 1, key-in-lever specifications.
- Return springs in rose trim provide positive lever return and sag prevention.
- Trim bottom out on 1 3/4" thick doors to prevent door collapse and trim bind.
- 24 functions available.
- Falcon interchangeable cores in 6 & 7 pin available.
- Heavy duty levers are 5" long and are solid (no inserts).
- 3 1/2" diameter rose to cover new metal door preparation (for key-in-lever locks). Also large enough to cover old paint marks on retrofits.
- 9/16" latch projection, one of the longest in the industry. Also available with 3/4" projection. Both are UL listed for 3 hour 'A' label doors.
- Large 10-32 thru-bolt screws for extra security. Screws treated with thread sealant to prevent loosening.
- Standard locks fit doors 1 3/4" - 2 1/4" thick without modification or special hardware.
- Locks are non-handed.
- Non-handed door preparation.

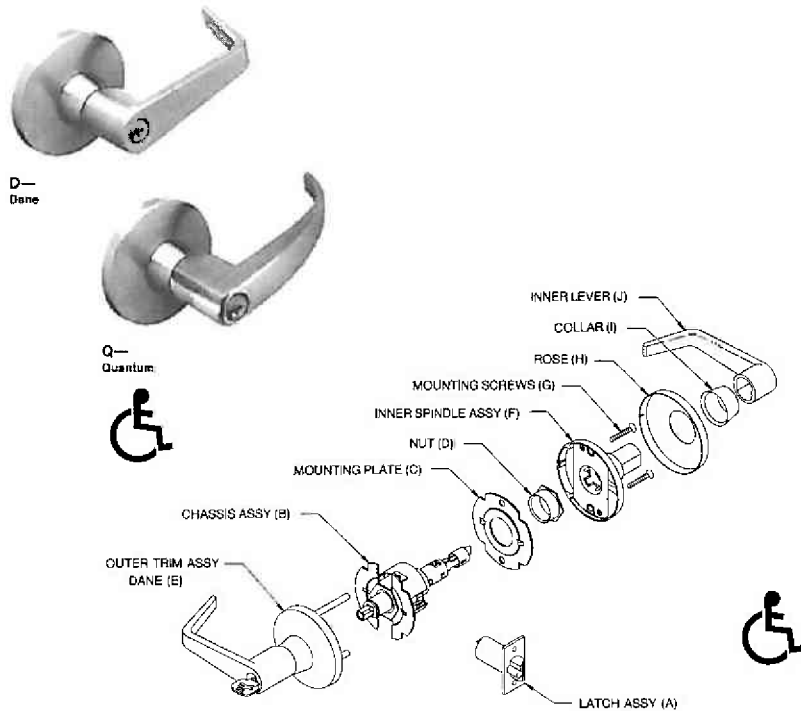

ALSO AVAILABLE IN IC CORE, AND OTHER REMOVEABLE CORES

- **Trim:** Roses are heavy wrought brass or bronze, installed over pressure cast rose inserts which are through-bolted through the door. Levers are pressure cast (solid levers-no inserts) material finished to match mating parts.
- **Mechanism:** Brass or cold formed steel, zinc plated and chromated for rust resistance. Springs are stainless steel.
- **Door Thickness:** 1 3/4" - 2 1/4".
- **Backset:** 2 3/4" standard; 3 3/4" and 5" also available.
- **Latchbolt:** 9/16" projection standard, 3/4" projection (2 3/4" only) available. Bevelled front standard; flat front available.
- **Strike:** 2 3/4" x 1 1/8" T strike No. A05185-000.
- **Cylinders:** G keyway standard in standard cylinder. IC Core

DANE

Code	Function	605	626
FAT101S	Passage/Closet	251.00	232.00
FAT301S	Privacy	308.00	290.00
FAT501PD	Entry	340.00	322.00
FAT561PD	Classroom	340.00	322.00
FAT581PD	Storeroom	340.00	322.00

QUANTUM

Code	Function	605	626
FAT101S	Passage/Closet	251.00	232.00
FAT301S	Privacy	308.00	290.00
FAT501PD	Entry	340.00	322.00
FAT561PD	Classroom	340.00	322.00
FAT581PD	Storeroom	340.00	322.00

B SERIES GRADE 2 KEY-IN-LEVER

All locks meet the new ANSI/BHMA A156.2-1996, Series 4000, Grade 2 test requirements for key-in-lever locksets.

Locksets are UL listed (1 1/2 hour B label)

Lever trim have individual heavy duty springs for lever return and to prevent lever sag. Trim is through-bolted with screws coated with thread sealant to provide strength and resistance to loosening.

Roses are 3 1/2" diameter.

Levers are solid (no inserts) and meet the federal ADA and state disability requirements.

Adjustable for door thickness 1 3/8" - 2".

Non-handed.



D—
Dane



Q—
Quantum

ALSO AVAILABLE IN IC CORE, AND OTHER REMOVEABLE CORES

DANE

Code	Function	605	606, 625	626
FAB101S	Passage/Closest	163.00	170.00	155.00
FAB301S	Privacy	191.00	196.00	180.00
FAB511PD	Entry/Office	225.00	228.00	216.00
FAB561PD	Classroom	225.00	228.00	216.00
FAB581PD	Storeroom	225.00	228.00	216.00

QUANTUM

Code	Function	605	606, 625	626
FAB101S	Passage/Closest	163.00	170.00	155.00
FAB301S	Privacy	191.00	196.00	180.00
FAB511PD	Entry/Office	225.00	228.00	216.00
FAB561PD	Classroom	225.00	228.00	216.00
FAB581PD	Storeroom	225.00	228.00	216.00

- **Trim:** Roses are 3 1/2" diameter, heavy wrought brass or bronze, installed over steel rose inserts which are through-bolted through the door. Levers are pressure cast (solid levers-no inserts) material finished to match mating parts.
- **Attachment:** Lock chassis secured to door by two screws which pass through a steel rose insert inside and thread directly into the outer rose mounting assembly.
- **Mechanism:** Parts constructed of brass or cold formed steel, zinc plated and dichromated for rust resistance. Springs are stainless steel.
- **Door Thickness:** 1 3/8" - 2" standard.
- **Backset:** 2 3/4" standard; 2 3/8", 3 3/4" and 5" also available.
- **Handing:** Lock are non-handed.
- **Latchbolt:** 1/2" projection UL listed. Latches have self-adjusting fronts to accommodate beveled or flat doors. 2 3/4" backset with 2 1/4" x 1" latchfaces. Deadlocking latches have a solid round bar stock DL bar preventing latch jamming and/or lock outs.
- **Strike:** 4 7/8" x 1 1/4" ASA strike No. A05164-000.
- **Cylinders:** G keyway standard in standard cylinder. Drilled 6, pinned 5. IC Core available.