

- CONCEALED SCREW SURFACE BOLTS
- CONCEALED SCREW SLIDE BOLTS

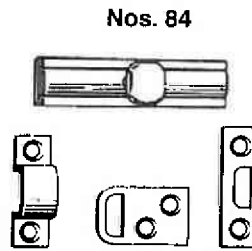

Solid Brass
Lengths: No. 84 — 2 1/2"

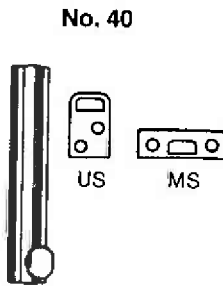
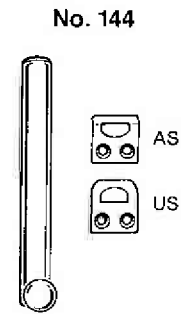

Solid Brass
Lengths: 4", 6", 9", 12"

40 CONCEALED SCREW SURFACE BOLTS

An outstanding line of modern surface bolts. Made of hand polished, extruded brass and aluminum.

Extremely strong and durable with interlocking construction and heavy gauge track and rod. Concealed rod installation; no marring of bolt. Tension spring holds bolt in position. Width: 5/8". Projection: 3/4".

Individually polybagged with screws and both universal and mortise strike. 10 per box. (Surface strike available on special order.)

Code	Length	Throw	Finish	Price
IV40B26-2	2"	7/16"	Bright Chrome	13.30
IV40B26D-2	2"	7/16"	Satin Chrome	13.30
IV40B3-2	2"	7/16"	Polished Brass	12.75
IV40B26-3	3"	11/16"	Bright Chrome	13.90
IV40B26D-3	3"	11/16"	Satin Chrome	13.90
IV40B3-3	3"	11/16"	Polished Brass	13.30
IV40B26-4	4"	15/16"	Bright Chrome	14.60
IV40B26D-4	4"	15/16"	Satin Chrome	14.60
IV40B3-4	4"	15/16"	Polished Brass	13.95
IV40B26-6	6"	15/16"	Bright Chrome	17.00
IV40B26D-6	6"	15/16"	Satin Chrome	17.00
IV40B3-6	6"	15/16"	Polished Brass	16.30
IV40B3-9	9"	15/16"	Polished Brass	21.80
IV40B26-9	9"	15/16"	Bright Chrome	22.81
IV40B26D-9	9"	15/16"	Satin Chrome	22.81
IV40B3-12	12"	15/16"	Polished Brass	26.40
IV40B26D-12	12"	15/16"	Satin Chrome	30.40

144 CONCEALED SCREW SURFACE BOLTS

Fully concealed, three-screw easy installation. With stainless steel tension spring that eliminates creep and prevents rod pull-out. 5/8" diameter half round rod; 1" projection; 1" throw.

Hand Polished Brass. Individually polybagged; 5 per box. Supplied with Universal and Angle strikes and hex key wrench.

Code	Length	Throw	Finish	Price
IV144B3-4	4"	1"	Polished Brass	20.70
IV144B26D-4	4"	1"	Satin Chrome	23.80
IV144B3-6	6"	1"	Polished Brass	23.30
IV144B26D-6	6"	1"	Satin Chrome	24.40
IV144B3-9	9"	1"	Polished Brass	23.30
IV144B26D-9	9"	1"	Satin Chrome	26.80
IV144B3-12	12"	1"	Polished Brass	28.10
IV144B26D-12	12"	1"	Satin Chrome	32.30

MODERN SLIDE BOLTS

Hand Polished Brass. Polybagged with screws; 10 per box. Supplied with Surface, Mortise and Universal strikes.

Code	Length	Throw	Finish	Price
IV84B3	2 1/2"	9/16"	Polished Brass	14.44
IV84B5	2 1/2"	9/16"	Antique Brass	16.53



•STRAPLESS SURFACE BOLTS •CHAIN DOOR GUARDS
•DELUXE SECURITY BOLTS

STRAPLESS SURFACE BOLTS

Exclusive Ives stainless steel tension spring prevents rod "pull-outs" and insures permanent spring tension. Attractive, semi-concealed guides assure smooth operation and eliminate rod marring. Knobs, rods and guides are attractively styled and well proportioned.

Solid Hand Polished Brass. Individually polybagged with screws. 043 and 43 -10 per box; 143-5 per box. Supplied with both Universal and Angle strikes. 143 furnished with guides in 12" length.

Nos. 043, 43

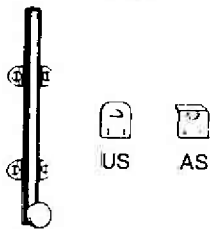

Solid Brass or Steel
No. 043 Lengths: 2", 3", 4", 6"
Brass only: 9"
No. 43 Lengths: 4", 6"
Brass only: 9", 12"

No. 143

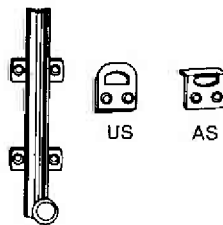

Solid Brass
Lengths: 6", 9", 12"

Code	Length	Half-Round Rod	Guides	Throw	Finish	Price
IV043B3-2	2"	3/8"	1 3/16"	3/8"	Polished Brass	12.50
IV043B26D-2	2"	3/8"	1 3/16"	3/8"	Satin Chrome	14.40
IV043B3-3	3"	3/8"	1 3/16"	3/4"	Polished Brass	13.00
IV043B26D-3	3"	3/8"	1 3/16"	3/4"	Satin Chrome	15.00
IV043B3-4	4"	3/8"	1 3/16"	3/4"	Polished Brass	13.40
IV043B26D-4	4"	3/8"	1 3/16"	3/4"	Satin Chrome	15.40
IV043B3-6	6"	3/8"	1 3/16"	3/4"	Polished Brass	14.20
IV043B26D-6	6"	3/8"	1 3/16"	3/4"	Satin Chrome	16.30
IV43B3-4	4"	1/2"	1 3/8"	1"	Polished Brass	14.90
IV43B26D-4	4"	1/2"	1 3/8"	1"	Satin Chrome	17.10
IV43B3-6	6"	1/2"	1 3/8"	1"	Polished Brass	16.60
IV43B26D-6	6"	1/2"	1 3/8"	1"	Satin Chrome	19.10
IV43B3-9	9"	1/2"	1 3/8"	1"	Polished Brass	21.30
IV43B26D-9	9"	1/2"	1 3/8"	1"	Satin Chrome	24.50
IV43B3-12	12"	3/8"	1 3/16"	3/4"	Polished Brass	23.70
IV43B26D-12	12"	3/8"	1 3/16"	3/4"	Satin Chrome	31.40
IV143B5-6	6"	5/8"	1 1/2"	1"	Antique Brass	20.14
IV143B26-6	6"	5/8"	1 1/2"	1"	Bright Chrome	20.14
IV143B26-9	9"	5/8"	1 1/2"	1"	Bright Chrome	22.94
IV143B26-12	12"	5/8"	1 1/2"	1"	Bright Chrome	27.72
IV143B26D-12	12"	5/8"	1 1/2"	1"	Satin Chrome	27.72

DELUXE SECURITY BOLTS

For the ultimate strength, security and simplicity in installation, with crisp and contemporary styling that blends with various door styles. Solid strength, hand polished brass bolt - 5/16" diameter, securely and permanently housed in an oversized precision-designed extrusion of solid brass.

The creep-proof bolt remains positively locked or unlocked. Full 5/8" throw. Individually polybagged, with three strikes and eight recessed head screws. 10 per box.

Nos. 87, 88

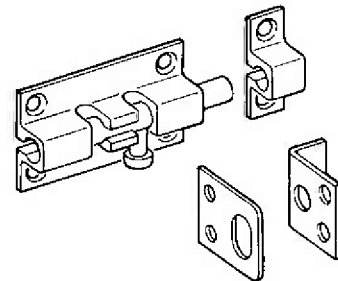

Solid Brass
Lengths: No. 87 - 2 1/4"

Code	Length	Width	Projection	Throw	Finish	Price
IV87B26	2 1/4"	1 1/4"	15/32"	5/8"	Bright Chrome	24.20
IV87B26D	2 1/4"	1 1/4"	15/32"	5/8"	Satin Chrome	24.20
IV87B3	2 1/4"	1 1/4"	15/32"	5/8"	Polished Brass	22.10

CHAIN DOOR GUARDS

Economy model. Design, detail and finish of the finest quality craftsmanship. Welded twist link steel chain. Solid Brass plate holder. Unusually narrow 11/16" chain holder for modern trims.

Hand Polished Wrought Brass. Individually polybagged with sheet metal screws; 10 per box.

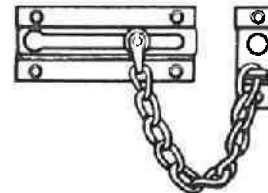

Solid Brass or Steel
Plate: 3 1/4" x 1 7/16"
Holder: 1 1/16" x 1 7/8"

Code	Finish	Price
IV481B3	Polished Brass	9.40
IV481B5	Antique Brass	10.90
IV481B26	Bright Chrome	10.90
IV481B26D	Satin Chrome	10.90



AskYourLocksmith.com
Lancaster, Pennsylvania
Phone 717-392-6333

•AUTOMATIC FLUSH BOLTS

DELUXE HEAVY DUTY SOLID BRASS SURFACE BOLTS

Rugged and handsome bolts for heavy doors. Extra heavy, 5/8" half round brass rod with 1 1/4" diameter knob. Bolts - 18" long and over. Furnished with three guides. Hand Polished Solid Brass. Packed with screws and one strike; 5 per box. Specify strike required.

No. 253

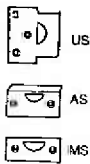

Solid Brass
Lengths:
8", 12", 18", 24", 30", 36"

No. 353

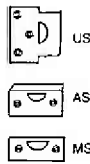

Solid Brass
Length: 8", 12", 18", 24"

No. 354

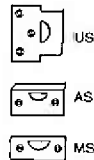

Solid Brass
Length: 8", 12", 18", 24"

HEAVY DUTY STEEL SURFACE BOLTS FOR INTERNAL AND EXTERNAL SECURITY

Accepts padlock (not furnished) with a maximum 3/8" diameter shackle; 1 3/4" minimum shackle opening height.

No. 360



Steel
Heavy Duty
Length: 12", 24"
U.L. Listed
(12" only)

No. 0454

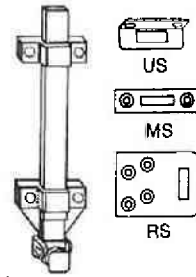

Steel
Lengths: 5", 8"
US
MS
RS

SB360 MAXIMUM SECURITY

All steel construction for maximum strength and heavy duty use. Designed for flush door application; use 1/8" shims under guides for hollow metal installation. 3/4" square steel rod-12" only - 1 1/4" throw - 2 1/32" overall width - 2 1/6" projection. Individually polybagged with universal strike, template and both standard and one-way sheet metal screws.

IVSB360T-24-2C
194⁰⁰

IVSB360T-12-2C
93⁰⁰

SB0454 SECURITY SURFACE BOLT

Designed specifically for both internal and external security. Accepts padlock when bolt homed. Throw: 1 3/16". Projection: 1 5/16". Overall Width: 2 1/32". 8" length individually polybagged with U.S. and M.S. one-way machine screws, one-way and standard sheet metal screws and template; 5" length supplied with universal top strike only. 8" unit packed with both a universal top strike and a mortise bottom strike.

IVSB0454-5-T-2C	5"	Zinc	41.00
IVSB0454-5-T-26D	5"	Satin Chrome	40.00
IVSB0454-8-TB-2C	8"	Zinc	43.00
IVSB0454-8-TB-26D	8"	Satin Chrome	51.00

Code	Length	Width of Guides	Throw	Finish	Price
IV253B3-8	8"	1 9/16"	1 1/8"	Polished Brass	54.00
IV253B5-8	8"	1 9/16"	1 1/8"	Antique Brass	62.10
IV253B3-12	12"	1 9/16"	1 1/8"	Polished Brass	71.00
IV253B5-12	12"	1 9/16"	1 1/8"	Antique Brass	65.95
IV253B3-18	18"	1 9/16"	1 1/8"	Polished Brass	84.80
IV253B3-24	24"	1 9/16"	1 1/8"	Polished Brass	102.10

IV353B3-8	8"	1 9/16"	1 1/8"	Polished Brass	59.40
IV353B26D-8	8"	1 9/16"	1 1/8"	Satin Chrome	68.30
IV353B3-12	12"	1 9/16"	1 1/8"	Polished Brass	71.40
IV353B3-24	24"	1 9/16"	1 1/8"	Polished Brass	107.80

IV354B3-8	8"	1 3/4"	7/8"	Polished Brass	94.00
IV354B3-12	12"	1 3/4"	7/8"	Polished Brass	115.70
IV354B3-24	24"	1 3/4"	7/8"	Polished Brass	155.90



- FLUSH BOLTS
- U. L. LABELED EXTENSION FLUSH BOLTS

No. 054

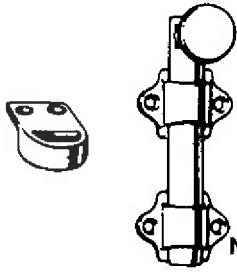

Solid Brass
Rod length: 4 1/4"

No. 54

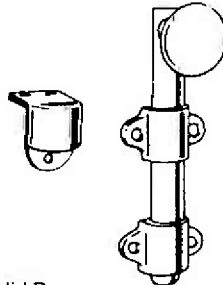

Solid Brass
Rod length: 4 1/4"

No. 55

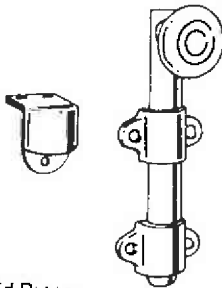

Solid Brass
Rod length: 4 1/4"

No. 56

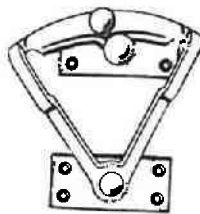

Solid Brass or Bronze
Size: 4 1/2" H. x 4 1/2" W.
Base: 2 3/4" x 1 1/4"

DUTCH DOOR BOLTS

Practical, rugged and attractive; for use on Dutch doors and areas requiring extra security. Easy to operate, even against weather stripping. Crisp design, enhanced by a 1 1/4" knob. Chamfered rod end draws the two leaves of the door tightly together. Guides and strikes are cast, while the rod is made of heavy 5/8" stock. 4 1/4" length.

Hand Polished Brass. Individually polybagged. Comes w/standard strike & screws.

Code	Width of Guide	Half-Round Rod	Throw	Finish	Price
IV054MB3	1 5/8"	5/8"	5/8"	Polished Brass	38.40
IV054MB15A	1 5/8"	5/8"	5/8"	Satin Nickel, Black	43.60
IV54B26	1 5/8"	5/8"	3/4"	Bright Chrome	51.54
IV55B26	1 5/8"	5/8"	3/4"	Bright Chrome	64.90
IV55B26D	1 5/8"	5/8"	3/4"	Satin Chrome	64.90
IV55B3	1 5/8"	5/8"	3/4"	Polished Brass	54.10
IV55B5	1 5/8"	5/8"	3/4"	Antique Brass	64.90

DUTCH DOOR QUADRANT-NON HANDED

Exclusive design, used to secure the top and bottom Dutch Doors - the most attractive and rugged non-handed Dutch quadrant available. Combines artistry craftsmanship and engineering excellence.

Base: 2 3/4" x 1 1/4". Overall Height: 4 1/2". Overall Width: 4 1/2"
Hand Polished Bronze. Individually boxed with screws.

IV56B26	Bright Chrome	63.60
IV56B3	Polished Brass	70.10
IV56B5	Antique Brass	84.10

MORTISE DOOR BOLTS

Hand polished brass knobs and escutcheons. 1 3/4" Strike; 1/2" Bolt. Individually polybagged with screws.

Nos. 45, S48

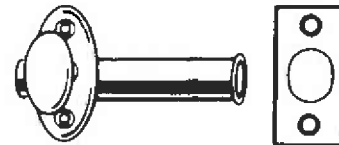

Solid Brass or Steel
Bracket: No. 45 2 5/8"
S48 1 3/4"

STEEL BOLT

Strong and smooth operating. Brass case.

Code	Backset	Throw	Finish	Price
IVS45B3	2 3/8"	1/2"	Polished Brass	20.60
IVS48B3	1 3/4"	1/2"	Polished Brass	14.50
IVS48B26D	1 3/4"	1/2"	Polished Brass	16.70

MORTISE DOOR BOLTS

Simplified installation-one step mortise. Short overall length; fits 2 1/2" stile. Only a quarter-turn of a key required to lock or unlock the door. 9/16" slim case. Strike: 2 1/2" x 13/16". Face Plate: 2 3/4" x 13/16". Throw: 1/2". Wrought Brass face, bolt and strike. Individually polybagged.

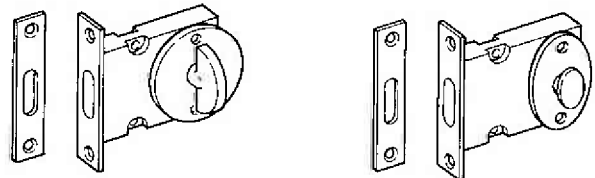

Solid Brass
with Aluminum Case
Backset: No. 150-1 3/4"
No. 152-2 1/2"
No. 154-2 3/4"

Solid Brass
with Aluminum Case
Backset: No. 151-1 3/4"
No. 153-2 1/2"
No. 155-2 3/4"

Code	Backset	Price	Code	Backset	Price
IV150B3	1 3/4"	40.80	IV151B3	1 3/4"	40.80
IV150B26D	1 3/4"	49.00	IV151B26D	1 3/4"	49.00
IV152B3	2 1/2"	40.80	IV153B3	2 1/2"	40.80
IV152B26D	2 1/2"	49.00	IV153B26D	2 1/2"	49.00
IV154B3	2 3/4"	40.80	IV155B3	2 3/4"	40.80
IV154B26D	2 3/4"	49.00	IV155B26D	2 3/4"	49.00



•AUTOMATIC FLUSH BOLTS

AUTOMATIC FLUSH BOLTS FOR LABELED METAL AND WOOD FIRE DOORS

Designed for hollow-metal, steel-covered or wood-covered composite fire door applications only. Recommended for doors that are normally held open or subject to low frequency use. Installed, top and bottom, on inactive leaf of a pair of doors. Fits 1 3/8" - 2 1/4" thick doors.

With positive latching and automatic unlatching features. Top and bottom bolts with full 15/16" throw; backset: 3/4". Bolt heads are equipped with bi-metal thermal lock safety device. Carry bar not required for astragal protection.

Brass. Nickel-plated, corrosion resistant shaft assembly. Packed one pair per box, with template and instructions for installation.

AUTOMATIC LOCKING FEATURE

When both fire doors are closed the ROD HEADS (top and bottom) will extend approximately 15/16" (23.8") beyond guides. During normal operation when active door is opened, bolts will retract and inactive door will be free to open. However, during a fire, when the temperature reaches about 170-180 degrees F. (76.7-82.2C.) the bi-metal locking arms on the rod heads begin to spread. These arms prevent the rod heads from retracting and keep the inactive door permanently locked.

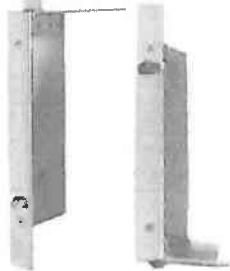

FB41P

Listed for use on the inactive leaf of a pair of classified wood-covered composite fire doors, swinging in pairs, not exceeding 1 1/2 hour fire rating or 8 feet in height. Simplified router mortise installation at the top and bottom corners of the door.

Furnished with sheet metal screws for bolts and strikes, and lead shields for the optional installation of standard bottom strike in a concrete floor. Sheet metal screws and shims furnished for wear plates. Machine screws for 1 3/4" standard door and bearing washers also supplied to reinforce door cutout.

159⁶⁰

per pair
One pair in a box.

ILFB41P-32D
ILFB41P-3

Satin Stainless Stl
Polished Brass

FB31P

Listed for use on the inactive leaf of a pair of classified hollow-metal fire doors with a maximum rating of three hours, not exceeding 9 feet in height; and on steel covered composite fire doors not exceeding 8 feet high. Fits standard A.N.S.I door and frame preparation. Built-in, self-aligning rods(axial play); no height adjustment required.

Machine screws furnished for bolts, guides and standard strikes; sheet metal screws and lead shields for optional installation of standard bottom strike in concrete floor. Shims, sheet metal and machine screws furnished for wear plate.

No. 559

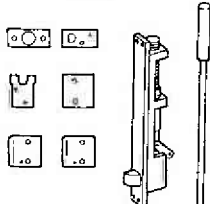

IVFB31P-32D
IVFB31P-3

151²⁰

per pair

Satin Chrome
Polished Brass

One pair in a box.

Steel and Brass
Components
For metal doors
U.L. Listed

DUST PROOF STRIKES

For Use With All IVES Automatic, Self-Latching and Manual Flush Bolts

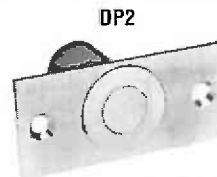

DP2

Floor and/or threshold
Solid Brass
Size: 3 1/2" x 1 5/8"



DP1

Threshold only
Solid Brass
Fits 1/16" hole

Will not lock up or down. Spring tension calibrated for positive closing and eliminates binding. DP1 plate used for flush floor conditions.

IVDP1-3	Polished Brass	21.40
IVDP1-10	Satin Bronze	21.40
IVDP1-26D	Satin Chrome	21.40

IVDP2-3	Polished Brass	27.00
IVDP2-26D	Satin Chrome	27.00

EXTENSION FLUSH BOLTS (non- UL)

No. 256, 257

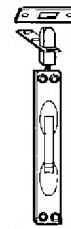

No. 256 - Solid Brass
Size: 6 3/8" x 3/4"
No. 257 - Solid Brass or Alum.
Size: 6 3/8" x 1 1/4"

No. 258

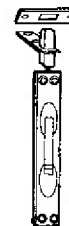

Solid Brass or Aluminum
"C" indicates convex face
Size: 6 3/8" x 1"

For use on installations not requiring U.L. label.

• Standard rod length is 12". Longer lengths available on special order.

• Extruded brass, aluminum slide and bolt head.

Backset: 5/8" Bolt Head: 1/2" sq. Throw: 3/4" Strikes: 29/16" x 1 1/32"

P/N	Finish of Rod	Price
IVFB256N-10B	Dark Bronze	35.00
IVFB256N-26	Polished Chrome	35.00
IVFB256N-26D	Satin Chrome	35.00
IVFB256N-3	Polished Brass	30.40
IVFB257N-10B	Dark Bronze	35.00
IVFB257N-26	Polished Chrome	35.00
IVFB257N-26D	Satin Chrome	35.00
IVFB257N-3	Polished Brass	30.40
IVFB258N-10B	Dark Bronze	35.00
IVFB258N-26	Polished Chrome	35.00
IVFB258N-26D	Satin Chrome	35.00
IVFB258N-3	Polished Brass	30.40



• FLUSH BOLTS
• U. L. LABELED EXTENSION FLUSH BOLTS

FLUSH BOLTS

Individually polybagged with screws.

No. 260 **Nos. 261, 262, 266** **No. 263, 264, 265**

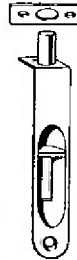
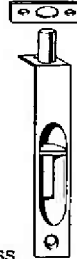

Solid Brass
No. 261-4" x 3/4"
No. 262-6" x 3/4"
No. 266-6 x 3/4"

No. 263
Solid Brass
Size: 5" x 3/4"

Nos. 264, 265
Solid Brass
and Aluminum
No. 264
Size: 4 1/2" x 3/4"
No. 265
Size: 6" x 3/4"

Solid Brass and Steel
Size: 6 1/2" x 3/4"

260

A wrought flush bolt specifically designed with a rounded face plate for simple, one-step router installation. Dual action spring lock that holds bolt projected or retracted for easy, one-finger operation. Economically priced for the volume builder.

Code	Finish of Rod	Backset	Dia. of Bolt Head	Bolt Head Material	Throw	Price
IV260B26D	Satin Chrome	3/8"	5/16"	Steel	3/4"	14.30
IV260B3	Polished Brass	3/8"	5/16"	Steel	3/4"	13.00

261

High quality compact cast flush bolt. Deep cut provides good finger hold for easy operation. Unique spring design holds bolt automatically in retracted or projected position.

Code	Finish of Rod	Backset	Dia. of Bolt Head	Bolt Head Material	Throw	Price
IV261B26D	Satin Chrome	15/32"	5/16"	Brass	3/4"	18.10
IV261B3	Polished Brass	15/32"	5/16"	Brass	3/4"	15.80

262

Exceptionally smooth working, superior quality cast flush bolt. Double action spring design provides automatic holding of bolt in projected or retracted position.

Code	Finish of Rod	Backset	Dia. of Bolt Head	Bolt Head Material	Throw	Price
IV262B26D	Satin Chrome	15/32"	1/2"	Brass	1"	26.50
IV262B3	Polished Brass	15/32"	1/2"	Brass	1"	23.00

263

Moderately priced, deluxe quality line of hand polished, cast flush bolts. Designed for easy, fast, low cost installation. Features rounded face plate and lip for simplified door preparation. Deep cup finger hole and double action spring combine to ease both the operation and automatic holding of the bolt in either projected or retracted position.

Code	Finish of Rod	Backset	Dia. of Bolt Head	Bolt Head Material	Throw	Price
IV263B26D	Satin Chrome	15/32"	5/16"	Brass	3/4"	20.70
IV263B3	Polished Brass	15/32"	5/16"	Brass	3/4"	18.00

264

Compact, moderately priced, deluxe quality cast flush bolt. Extra long lip permits applications in a variety of construction designs.

Code	Finish of Rod	Backset	Dia. of Bolt Head	Bolt Head Material	Throw	Price
IV264B26	Polished Chrome	15/32"	5/16"	Brass	3/4"	20.70
IV264B3	Polished Brass	15/32"	5/16"	Brass	3/4"	18.00

No. 358



Solid Brass
For wood doors

U. L. Listed

No. 457



Solid Brass or Aluminum
Rod lengths:
6", 9", 12", 18", 24"

No. 458



Solid Brass or Aluminum
Rod lengths:
6", 9", 12", 18", 24"

U. L. Listed
No. 458
Brass
(12" only)

No. 457 1/2



Solid Brass or Aluminum
Rod lengths:
6", 9", 12", 18", 24"

Standard 457B and 458B extension flush bolts have been listed by Underwriters Laboratories for use on Class A, B, C, D, and E labeled doors.

358 LABELED WOOD DOOR EXTENSION FLUSH BOLT

Specifically designed for installation in all types of labeled wood covered composite doors. Requires only simple router mortise at top and bottom corners of the door. Top and bottom strikes comply with A. N. S. I. standard dimensions for manual bolts. Fits 1 3/8" to 2 1/4" thick doors. Not available for Rabbeted door installation.

Individually polybagged; two per box, with template, sheet metal screws for bolts and strikes, and machine screws (for standard 1 3/4" thick door) and bearing washers to reinforce door cutout.

Code	Finish of Rod	Backset	Dia. of Bolt Head	Bolt Head Material	Throw	Price
IVFB358-26D	Satin Chrome	3/4"	1/2"	Brass	3/4"	29.50
IVFB358-3	Polished Brass	3/4"	1/2"	Brass	3/4"	29.50

457 and 458 EXTENSION FLUSH BOLTS FOR METAL DOORS

Listed for use in hollow metal, metal clad, steel covered composite and sheet metal doors. Provides simplified installation in metal frames - round bolt head requires only a punched hole; use of strike optional. Specially designed guide and the bolt's flat side prevents turning.

Standard rod length: 12". Extruded Brass.

Packed with combination machine and wood screws for all parts.

Code	Finish of Rod	Backset	Dia. of Bolt Head	Bolt Head Material	Throw	Price
IVFB457-10	Satin Bronze	3/4"	1/2"	Brass	3/4"	22.00
IVFB457-26D	Satin Chrome	3/4"	1/2"	Brass	3/4"	22.00
IVFB457-3	Polished Brass	3/4"	1/2"	Brass	3/4"	22.00
IVFB457-10B	Dark Bronze	3/4"	1/2"	Brass	3/4"	22.00

IVFB458-10	Satin Bronze	3/4"	1/2"	Brass	3/4"	18.50
IVFB458-26D	Satin Chrome	3/4"	1/2"	Brass	3/4"	17.40
IVFB458-3	Polished Brass	3/4"	1/2"	Brass	3/4"	18.50
IVFB458-10B	Dark Bronze	3/4"	1/2"	Brass	3/4"	18.50

457N EXTENSION FLUSH BOLTS FOR METAL DOORS-NON UL LISTED

The same specifications and packaging as above.

Extruded Brass and Aluminum; Hand Polished.

Code	Finish of Rod	Backset	Diam. of Bolt Head	Bolt Head Material	Throw	Price
IVFB457 N-10	Satin Bronze	3/4"	1/2"	Brass	3/4"	22.00
IVFB457 N-26D	Satin Chrome	3/4"	1/2"	Brass	3/4"	22.00
IVFB457 N-3	Polished Brass	3/4"	1/2"	Brass	3/4"	22.00



AskYourLocksmith.com
Lancaster, Pennsylvania
Phone 717-392-6333

•SELF LATCHING FLUSH BOLTS
•HEAVY DUTY SECURITY SURFACE BOLTS

SELF-LATCHING FLUSH BOLTS

U.L. Listed. Brass Components.
Specially designed for installation in pairs on the inactive leaf of paired door openings where the inactive leaf is not required for exit purposes. Doors must be equipped with a coordinator. *Sold in pairs.*

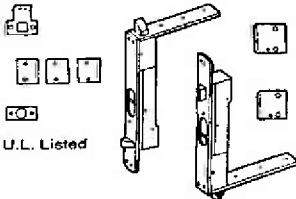

IVFB61P-3 Polished Brass
IVFB61P-10 Satin Bronze
IVFB61P-32 Polished Stainless Steel
IVFB61P-32D Satin Stainless Steel

159⁶⁰

FB61P FOR WOOD DOORS

Used with labeled wood-covered composite fire doors not exceeding a 1 1/2 hour fire rating in 8 feet in height.

U.L. Listed

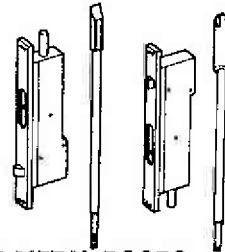
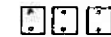

IVFB51P-32D Satin Stainless Steel
IVFB51P-3 Polished Brass
IVFB51P-10 Satin Bronze

151²⁰

FB51P FOR METAL DOORS

Used for labeled hollow metal fire doors, not exceeding 9 feet in height, and on steel-covered composite fire doors, not exceeding 8 feet in height; both with a maximum rating of three hours.

Fits ANSI A115.4 door preparation for manual bolts. Spring actuated; manually retracted.

Sold in pairs.

HEAVY DUTY SECURITY SURFACE BOLTS

Listed by Underwriters Laboratories for use on the inactive leaf of a pair of doors.

- Standard Surface Bolt has 1" throw
- Ideal for all types of doors
- Fully concealed mounting prevents vandalism
- Available in locking version. Unit locks in both the up and down position. Locking bolts are furnished with 2 keys in 4 keying variations.
- Units packed with wood and machine screws to meet most field conditions.
- Constructed of heavy duty steel
- UL listed up to 3 hours when used on the inactive door of a pair up to 8' in height.
- Meets ANSI/BHMA A156.16, L84161

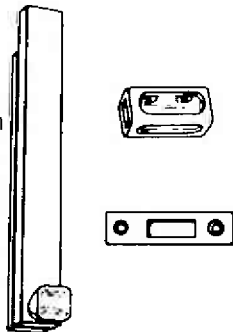

Steel
Concealed Screws
Length: 8"

U.L. Listed

SB1630 CONCEALED SCREW SECURITY SURFACE BOLT

Body: 8" long x 7/8" wide x 3/4" thick

Overall Knob or Lock Housing Projection: 1 1/2"

Top Strike: 1 1/4" wide x 7/8" tall x 15/16" deep

Bottom Strike: 3" long x 1" wide x 1/8" thick

IVSB1630B-26D	Bottom Bolt	Satin Chrome	50.00
IVSB1630BL-26D	Locking Top Bolt	Satin Chrome	91.00
IVSB1630T-2G	Top Bolt	Zinc Plated	39.00
IVSB1630T-26D	Top Bolt	Satin Chrome	55.00
IVSB1630TB-10B	Top/Bottom Bolt	Dark Bronze	96.00
IVSB1630TBL-10B	Top/Bottom Locking	Dark Bronze	124.00
IVSB1630TBL-26D	Top/Bottom Locking	Satin Chrome	109.00
IVSB1630TL-26D	Top/Bottom	Satin Chrome	99.00

SB453 SURFACE BOLT

Hand polished, all-steel construction for heavy duty use. Rod: 3/4" wide x 1/4" thick. 1 3/16" extra long throw for added security. 1 5/16" projection with an overall width of 2 1/32".

Individually polybagged with strike specified, and both machine and sheet metal screws.

Code	Length	Finish	Price
IVSB453-8-TB-2C	8"	Zinc	34.00
IVSB453-12-TB-2C	12"	Zinc	43.00
IVSB453-8-TB-10	8"	Satin Bronze	41.00
IVSB453-12-TB-10	12"	Satin Bronze	46.00
IVSB453-8-TB-26D	8"	Satin Chrome	42.00
IVSB453-12-TB-26D	12"	Satin Chrome	53.00
IVSB453-18-TB-2C	18"	Zinc	68.00
IVSB453-24-TB-2C	24"	Zinc	88.00

SB454 SECURITY SURFACE BOLT

Designed specifically to prevent manipulation. Positively holds bolt in locked position.

Hand polished, all-steel construction for heavy duty use. Rod: 3/4" wide x 1/4" thick. 1 3/16" extra long throw for added security. 1 5/16" projection with an overall width of 2 1/32".

8" and 12": Individually polybagged with U.S. and M.S. template, and both machine and sheet metal screws. 5": Individually polybagged, packed with U.S., with 1/8" shim, installation and sheet screws only.

Code	Length	Finish	Price
IVSB454-5-T-3	5"	Polished Brass	33.00
IVSB454-5-T-4	5"	Satin Brass	34.01
IVSB454-5-T-10	5"	Satin Bronze	34.01
IVSB454-5-T-26D	5"	Satin Chrome	38.00

IVSB454-8-TB-3	8"	Polished Brass	36.00
IVSB454-8-TB-10	8"	Satin Bronze	34.84
IVSB454-8-TB-26D	8"	Satin Chrome	39.00

IV454-12-TB-3	12"	Polished Brass	41.00
IV454-12-TB-10	12"	Satin Bronze	38.73
IV454-12-TB-26D	12"	Satin Chrome	43.00



- DOOR SILENCERS**
- HINGE PIN DOOR STOP**
- ROLLER BUMPERS**
- Metal Frame •Wood Frame**
- FLEXIBLE DOOR STOP**

"QUICK STALL" FLEXIBLE DOOR STOP

Burnished Wrought Steel. Safe, practical, simple to install. Individually polybagged, 50 per box; with sheet metal screws for wood or metal application.

Code	Projection	Finish	Price
IV060F14	3"	Bright Nickel	.90
IV060F3	3"	Bright Brass	.90
IV061F14	4"	Bright Nickel	1.00
IV061F3	4"	Bright Brass	1.00

Nos. 060, 061



Steel
No. 060 Projection: 3"
No. 061 Projection: 4"

No. 69



Steel
Door Openings: 70"-100"

No. 70



Aluminum
Door Openings: 85"-125"

HINGE PIN FOR DOOR STOPS

The solution for locations where the installation of a standard door stop creates problems. Can be used on most types of hinged doors, while protecting walls, furniture and doors. Removable bushings accommodate 1/4" to 5/16" diameter hinge pins.

69
Burnished Wrought Steel. Positive slip-proof adjustment for door opening from 70;dg to 100;dg. Unbreakable, heavy gauge steel for a lifetime of service. Individually polybagged; 20 per box.

IV69F3	Bright Brass	3.60
--------	--------------	------

70
Burnished Cast Aluminum. For narrow trim installation. Provides a wide range of angular adjustment, from 85° to 125°. Permanently molded and cross-section designed. Features high quality rubber bumpers.

IV70A3	Polished Brass	1.80
IV70A92	Aluminum	1.80

ROLLER BUMPERS

Hand Polished Cast Brass roller bumpers eliminate the possibility of interlocking knobs, or of interfering doors from striking each other. Individually packed with sheet metal screws; 2 per box.

No. 470



Solid Brass
Reach: 2 3/4"

Nos. 471, 472

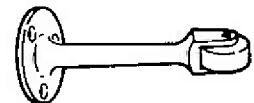

Solid Brass
471 - 4 1/2" Projection
472 - 6" Projection

RB470

Offset Arm type; used where two left hand or two right hand doors interfere, meeting a odd angles in a corner. Conforms to Federal Spec. No. 1342. Base: 1 5/8" x 2 1/4". Projection: 2 3/4". Reach: 2 3/4".

IVRB470-26D	Satin Chrome	31.60
IVRB470-3	Polished Brass	25.30

RB471

Straight Stem type; used where the doors in a corner are of opposite type. Base: 2" diameter. Projection: 4 1/2". Conforms to Federal Spec. No. 1341.

IVRB471-26D	Satin Chrome	28.70
IVRB471-3	Polished Brass	23.90

RB472

Straight stem type; used where the doors in a corner are of opposite type. Base: 2" diameter. Projection: 6". Conforms to Federal Spec. No. 1341A.

IVRB472-26D	Satin Chrome	30.40
IVRB472-3	Polished Brass	25.40

DOOR SILENCERS

Gray Rubber. For use on **metal frames**. Packed 100 per polybag with 1 inserter.

IVSR64 25.20/bag

Gray Rubber. For use on **wood frames**. Packed 100 per polybag with 1 inserter.

IVSR65 25.20/bag

Gray Rubber. Self adhesive, requires no drilling of frame. Packed in sheets of 100.

IVSR66 25.20/sheet



SR64



SR65



SR66



411R

WALL DOOR STOP

Self-adhesive bumper for use on clean, smooth flat surfaces only - glass, tile, metal, plaster or wood.

Material: Molded elastomeric Polymer. Overall Diameter: 1 7/8". Projection: 5/8". Packed 20 per box.

230 ea.

IV411R-G Gray Rubber
IV411R-W White Rubber



AskYourLocksmith.com
Lancaster, Pennsylvania
Phone 717-392-6333

•HEAVY DUTY DOOR STOPS
•Wall •Floor

•HEAVY DUTY DOOR STOPS AND HOLDERS

HEAVY DUTY DOOR STOPS

Finest quality, heavy duty door stops designed specially for commercial and public buildings. Features non-marring rubber tip. Hand Polished Cast Brass

No. 443

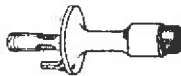

Solid Brass or Aluminum
Projection: 3/4"

No. 444



Solid Brass or Aluminum
Height: 3"

No. 447

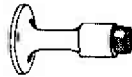

Solid Brass or Aluminum
Projection: 3/4"

No. 448



Solid Brass or Aluminum
Height: 3"

WS443 WALL STOP

Conforms to Federal Spec. No. 1320E
Projection: 3 5/8". Base Diameter: 2 1/4".
Packed individually with expansion shields; 2 per box.

IVWS443-3	Polished Brass	29.30
IVWS443-10	Satin Bronze	35.20
IVWS443-26D	Satin Chrome	35.20
IVWS443-28	Satin Aluminum	25.00

FS444 FLOOR STOP

Conforms to Federal Spec. No. 1328E. Designed for doors with undercut up to 2 1/2".
Height: 3". Base Diameter: 2 1/2".
Packed individually with expansion shields; 2 per box.

IVFS444-3	Polished Brass	22.30
IVFS444-10	Satin Bronze	22.30
IVFS444-26D	Satin Chrome	21.40
IVFS444-28	Satin Aluminum	15.70

WS447 WALL STOP

Conforms to Federal Spec. No. 1320. Designed for doors with undercut up to 2 81/2".
Height: 3 5/8". Base Diameter: 2 1/4".
Packed with screws; 2 per box.

IVWS447-3	Polished Brass	26.60
IVWS447-10	Satin Bronze	32.00
IVWS447-26D	Satin Chrome	32.00
IVWS447-28	Polished Aluminum	22.70

FS448 FLOOR STOP

Conforms to Federal Spec. No. 1328. Designed for doors with undercut up to 2 1/2".
Height: 3". Base Diameter: 2 1/2".
Packed with screws; 2 per box.

IVFS448-3	Polished Brass	25.10
IVFS448-10	Satin Bronze	25.10
IVFS448-26D	Satin Chrome	25.10
IVFS448-28	Polished Aluminum	18.60

HEAVY DUTY DOOR STOPS AND HOLDERS

Finest quality, heavy duty door stops designed specially for commercial applications, public buildings and high traffic areas. Hand Polished Cast Brass.

No. 445



Solid Brass or Aluminum
Projection: 3/4"

No. 446

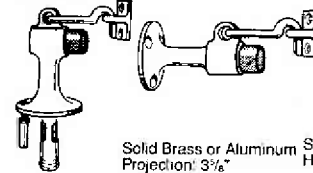

Solid Brass or Aluminum
Height: 3"

No. 449

No. 449

No. 450

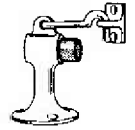

Solid Brass or Aluminum
Height: 3"

No. 451



Solid Brass or Aluminum
Height: 3"

WS445 WALL STOP

Conforms to Federal Spec. No. 1321E.
Projection: 3 5/8". Base Diameter: 2 1/4".
Packed with screws and expansion shields; 2 per box.

IVWS445-3	Polished Brass	46.50
IVWS445-10	Satin Bronze	55.80
IVWS445-26D	Satin Chrome	55.80
IVWS445-28	Polished Aluminum	39.50

FS446 FLOOR STOP

Conforms to Federal Spec. No. 1329E. Designed for doors with undercut up to 2 1/2".
Projection: 3 5/8". Base Diameter: 2 1/2".
Packed with screws and expansion shields; 2 per box.

IVFS446-3	Polished Brass	44.30
IVFS446-10	Satin Bronze	44.30
IVFS446-26D	Satin Chrome	31.40
IVFS446-28	Polished Aluminum	22.90

WS449 WALL STOP

Conforms to Federal Spec. No. 1321.
Projection: 3 5/8". Base Diameter 2 1/4".
Packed with screws; 2 per box.

IVWS449-3	Polished Brass	44.40
IVWS449-10	Satin Bronze	53.20
IVWS449-26D	Satin Chrome	53.20

FS450 FLOOR STOP

Conforms to Federal Spec. No. 1329. Designed for doors with undercut up to 2 1/2".
Projection: 3 5/8". Base Diameter: 2 1/2".
Packed with screws; 2 per box.

IVFS450-3	Polished Brass	47.10
IVFS450-10	Satin Bronze	47.10
IVFS450-26D	Satin Chrome	47.10
IVFS450-28	Polished Aluminum	25.70

FS451 FLOOR STOP

Conforms to Federal Spec. No. 1329E. Designed for doors with undercut up to 2 1/2".
Projection: 3 1/8". Base: 2 11/16"(L), 1 5/8"(W).
Individually polybagged; 2 per box. Plate and holder furnished with sheet metal screws.

IVFS451-10	Satin Bronze	48.60
------------	--------------	-------



• FLOOR DOOR STOPS
• BASE DOOR STOPS

FLOOR DOOR STOPS

No. 430



Solid Brass or Aluminum
Height: 1 5/8"

No. 434

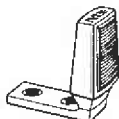

Steel
Height: 2 1/2"

No. 441



Solid Brass or Aluminum
Height: 2 1/4"

No. 442



Solid Brass or Aluminum
Height: 2 1/8"

430 FLOOR STOP

Base Diameter: 1 1/4". Height: 1 5/16". With replaceable rubber tip. Machine Polished Cast Brass. Individually polybagged.

IV430MB5	Antique Brass	14.90
IV430MB26	Bright Chrome	14.90

FS434 FLOOR STOP

For undercut doors. Wrought steel with soft, resilient rubber. Overall Length: 2 3/4". Width: 1 5/8". Height: 2 1/8". Individually polybagged; with sheet metal screws and plastic anchor.

IVFS434-2C	Zinc	7.40
------------	------	------

FS441 FLOOR STOP

For doors, undercut to 1 1/2". Width non-marring rubber tip. Overall Length: 2 11/16". Width: 1 5/8". Height: 2 1/8". Supplied with metal screws. Hand Polished Cast Brass. Individually polybagged.

IVFS441-3	Polished Brass	18.90
IVFS441-26D	Satin Chrome	18.30

FS442 FLOOR STOP

For doors, undercut to 2". With non-marring rubber tip. Overall Length: 2 11/16". Width: 1 5/8". Height: 2 7/8". Meets Federal Specs. - Type 1328. Hand Polished Cast Brass. Individually polybagged.

IVFS442-3	Polished Brass	24.30
IVFS442-26D	Satin Chrome	21.70

BASE DOOR STOPS

Individually polybagged; 10 per box.

Nos. 60, 61

No. 62

No. 62

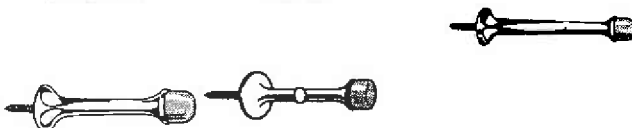

No. 64 Solid Brass or Aluminum
Projection: 4 1/2" No. 65

Solid Brass or Aluminum
No. 60 Projection: 3 3/4"
No. 61 Projection: 3"

Solid Brass or Aluminum
Projection: 2 1/2"

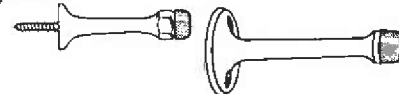

Solid Brass or Aluminum
Projection: 3 1/4"

Aluminum
Projection: 3 1/4"

60 DOOR STOP

Machine Polished Cast Brass. Projection: 3 3/4"

IV60MB3	Polished Brass	10.00
IV60MB5	Antique Brass	11.12
IV60MB26	Bright Chrome	13.40
IV60MB26D	Satin Chrome	13.40

61 DOOR STOP

Machine Polished Cast Brass. Projection: 3". Conforms to Federal Spec. 1322

IV61MB3	Polished Brass	10.00
IV61MB26	Bright Chrome	13.40
IV61MB26D	Satin Chrome	10.00

062 DOOR STOP

Machine Polished Cast Brass. Projection: 2 1/2". Conforms to Federal Spec. 1323.

IV062MB3	Polished Brass	9.10
IV062MB5	Antique Brass	7.40
IV062MB26D	Satin Chrome	9.10

62 DOOR STOP

Machine Polished Cast Brass. Projection: 4 1/2"

IV62MB26D	Satin Chrome	16.30
IV62MB3	Polished Brass	13.70

64 DOOR STOP

Machine Polished Cast Brass. Projection: 3 1/4".

IV64MB3	Polished Brass	9.10
IV64MB26D	Satin Chrome	11.70

WS65 DOOR STOP

Brushed Cast Aluminum. Projection: 3 3/4". Individually polybagged, 20 per box; with sheet metal screws.

IVWS65A3	Polished Brass	3.90
IVWS65US27	Aluminum	3.90



AskYourLocksmith.com
Lancaster, Pennsylvania
Phone 717-392-6333

- DOORS STOPS AND HOLDERS
- DOME DOOR STOPS
- LOCKGUARDS

LOCK GUARDS

LG10, LG12



LG14



P/N	Material	Size	Price
IVLG10-USP	Steel, Prime Painted	2 1/2" x 9 1/2"	20.90
IVLG10-32D	Stainless Steel	2 1/2" x 9 1/2"	30.90
IVLG12-USP	Steel, Prime Painted	1 1/2" x 9 1/2"	20.90
IVLG12-32D	Stainless Steel	1 1/2" x 9 1/2"	28.70
IVLG14-32D	Stainless Steel	2 9/16" x 9 1/2"	45.20

DOME DOOR STOPS

Hand Polished Cast Brass. With gray, non-marring rubber bumper. Individually polybagged with wood screws and plastic anchors; 10 per box.

No. 436

No. 438



FS436 Solid Brass or Aluminum
Height: 1"

Solid Brass or Aluminum
Height: 1 1/4"

For doors without threshold. Conforms to Fed Spec. No. 1330.
Height: 1" Base: 2" x 1 5/8". Stud Projection: 3/4".

IVFS436-3	Polished Brass	5.30
IVFS436-10	Satin Bronze	6.00
IVFS436-26	Bright Chrome	5.60
IVFS436-26D	Satin Chrome	4.50

FS438

For doors with threshold or undercut doors. Conforms to Fed Spec. No. 1330A.
Height: 1 5/8". Base: 2" x 1 5/8". Stud Projection: 3/4".

IVFS438-3	Polished Brass	6.20
IVFS438-10	Satin Bronze	7.10
IVFS438-26	Bright Chrome	6.70
IVFS438-26D	Satin Chrome	5.00

DOOR HOLDERS

No. 452

No. 455



Solid Brass or Aluminum
Arm Length: 4", 5"

Solid Brass or Aluminum
Arm Length: 4"

FS452 DOOR HOLDER

Features rugged construction, stainless steel spring and foot-operated replaceable rubber tip. Commercial use; allows door to stay open in desired position. Conforms to Federal Spec. No. 1149A-4" and Federal Spec. No. 1149B-5" - brass only.

Hand Polished Cast Brass. Individually polybagged with sheet metal screws; 10 per box.

Code	Arm Length	Finish	Price
IVFS452-3-4	4"	Polished Brass	24.30
IVFS452-26D-4	4"	Satin Chrome	23.40
IVFS452-26D-5	5"	Satin Chrome	28.90
IVFS452-3-5	5"	Polished Brass	33.70

FS455 DOOR HOLDER

Provides quality and sturdy construction with economy. Features stainless steel spring and foot-operated replaceable rubber tip. Allows door to stay open in desired position.

Arm Length: 4". Conforms to Federal Spec. No. 1149A - brass only. Available in Machine Polished Cast Brass or Burnished Cast Aluminum. Individually polybagged with sheet metal screws; 10 per box.

Code	Material	Finish	Price
IVFS455A3	Aluminum	Polished Brass	6.50
IVFS455A92	Aluminum	Aluminum	6.50
IVFS455MB3	Brass	Polished Brass	26.30
IVFS455MB26D	Brass	Satin Chrome	31.50



•RUBBER WALL BUMPERS

•Concave •Convex •Cast •Wrought

401 SERIES WALL BUMPERS

Positive attachment to the wall by tamper proof, concealed set screw. Soft, high grade light gray rubber cushion. The special retainer cup makes the rubber almost impossible to remove from the bumper.

Hand Polished Cast Brass. Individually polybagged, 10 per box; with socket head set screws

406 SERIES WALL BUMPERS

Lower cost alternative to the 401 Series; identical in size and similar in function, with high quality Ives finish. Hand Polished Wrought Brass. Individually polybagged, 10 per box; with socket head set screws

P/N	3	5	10	10B	26	26D	28	32D
WS401CCV	12.50		15.10	15.10	15.10	15.10	10.00	
WS401CVX	12.50		15.10	15.10	15.10	15.10	10.00	
WS402CCV	13.70	16.40	16.40	16.40	16.40	16.40	11.00	
WS402CVX	13.70		16.40	16.40	16.40	16.40	11.00	
WS404CVX	4.80	5.20	5.70	5.70	5.70	5.70		
WS406CCV	3.40	3.40	3.70	3.70	3.70	3.40	3.40	2.70
WS406CVX	3.40	3.40	3.70	3.70	3.40	3.40	3.40	2.70
WS407CCV	3.40	3.40	3.70	3.70	3.70	3.40	3.40	2.70
WS407CVX	3.40	3.40	3.70	3.70	3.70	3.40	3.40	2.70
408					6.50			6.30
408 1/2			6.50			6.50	5.70	6.30
409 1/2	6.00	6.00	6.00	6.00	6.00	6.00	6.00	6.00

WS401CVX

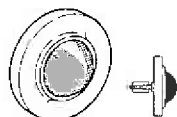

Cast Brass or Aluminum
Convex Rubber
Diameter: 2 1/2"

WS401CCV

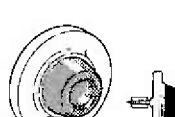

Cast Brass or Aluminum
Concave Rubber
Diameter: 2 1/2"

WS402CVX

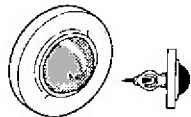

Cast Brass or Aluminum
Convex Rubber
Diameter: 2 1/2"

WS402CCV

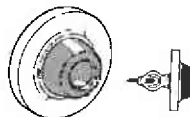

Cast Brass or Aluminum
Concave Rubber
Diameter: 2 1/2"

WS404CVX



Solid Brass
Convex Rubber
Rawl Plug
Diameter: 1"

WS406CVX

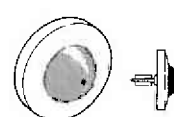

Wrought Brass, Stainless
Steel or Aluminum
Convex Rubber
Diameter: 2 1/4"

WS406CCV

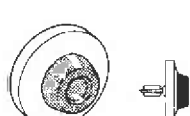

Wrought Brass, Stainless
Steel or Aluminum
Concave Rubber
Diameter: 2 1/4"

WS407CVX

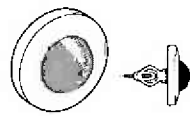

Wrought Brass, Stainless
Steel or Aluminum
Convex Rubber
Diameter: 2 1/4"

WS407CCV

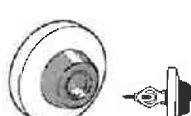

Wrought Brass, Stainless
Steel or Aluminum
Concave Rubber
Diameter: 2 1/4"

408



Wrought Brass, Stainless
Steel or Aluminum
Convex Rubber
Diameter: 2 1/4"

408 1/2

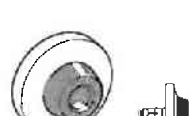

Wrought Brass, Stainless
Steel or Aluminum
Concave Rubber
Diameter: 2 1/4"

409 1/2



Wrought Brass, Stainless
Steel or Aluminum
Concave Rubber
Diameter: 1 3/4"



AskYourLocksmith.com
Lancaster, Pennsylvania
Phone 717-392-6333

- HEAVY DUTY MAGNETIC CATCHES
- DRAWER PULLS •PUSH LATCHES

PUSH LATCH

820

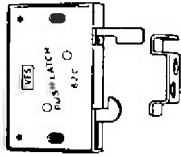

2 5/16" x 1 1/2" x 5/16"

CL14



Dimensions
Box: 2 1/8" x 1 1/2" x 5/16" (W x H x D)

For use on cabinet doors; the ideal catch when concealed hardware is desired. Eliminates the need for pulls or knobs while enhancing styling and the clean look of fine furniture and cabinets. Narrow case design for minimum obstruction; facilitates cleaning and painting.

Features heavy gauge parts. Simple installation with metal template; no mortising required.

CL11, CL12 and CL14 are designed for larger doors and panels.

Individually polybagged with screws template and instructions for installation.



CL11

Dimensions
Box: 1 1/8" x 1 1/2" x 5/16" (W x H x D)



CL12

Dimensions
Box: 2 1/8" x 1 1/2" x 5/16" (W x H x D)

Code	Finish	Price
IV820F2C	Zinc	11.90
IVCL11-US4	Brass-Satin Brass	26.60
IVCL12-US4	Brass-Satin Brass	35.80
IVCL12-US10	Satin Bronze	35.80
IVCL12-US26D	Satin Chrome	35.80
IVCL12-US3	Polished Brass	40.40
IVCL14-US4	Brass-Satin Brass	30.00
IVCL14-US26D	Satin Chrome	30.00

DRAWER PULLS

Nos. 32, 33, 34
36, 37, 38

No. 133

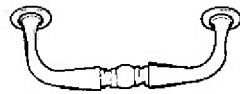

Solid Brass or Aluminum

- No. 32 - 2 1/2" C to C
- No. 33 - 5" C to C
- No. 34 - 6" C to C
- No. 36 - 3" C to C
- No. 37 - 3 1/2" C to C
- No. 38 - 4" C to C

Solid Brass
C to C: 3", 3 1/2", 4"

For use on doors, drawers and cabinets. Size: C-C Projection: 1 5/16". Diameter: 5/16".

Hand Polished Solid Brass; polished brass finish. Individually polybagged, 10 per box; with 1" x 8-32 Truss Head machine screws.

P/N	C-C"	3	5	26	26D
IV33	5	6.90	7.60	7.90	7.90
IV34	6	8.50	8.11	9.80	9.80
IV36	3	5.30	5.80	6.00	6.10
IV37	3 1/2	5.80	6.40	6.70	6.70
IV38	4	6.40	7.00	7.40	7.40
IV133-3"	3	16.20			20.50
IV133-3 1/2"	3 1/2	19.40			21.50
IV133-4"	4	20.20			22.20

HEAVY DUTY MAGNETIC CATCHES

No. 326

No. 327

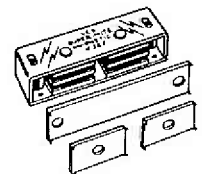
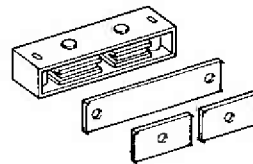

Aluminum Case
Dual Double Pole
Size: 3 1/8" x 1" x 3/16"

Aluminum Case
Dual Triple Pole
Size: 3 1/8" x 1" x 3/4"

MIGHTY-MITE® HEAVY DUTY MAGNETIC CATCHES

Designed for full length doors. Features self-aligning pole piece and magnet. Unique aluminum case design permits surface mounting or mortising into stop. Individually polybagged with instructions, sheet metal screws, 1 long and 2 short strikes; 10 per box.

DUAL TRIPLE POLE

IV327A3	3 1/8" x 3/4"	Steel-Brass	11.30
IV327A5	3 1/8" x 3/4"	Steel-Antique Brass	11.30
IV327A92	3 1/8" x 3/4"	Steel-Aluminum	10.00

DUAL DOUBLE POLE

IV326A3	3 1/8" x 9/16"	Steel-Brass	6.60
IV326A5	3 1/8" x 9/16"	Steel-Antique Brass	6.60
IV326A92	3 1/8" x 9/16"	Steel-Aluminum	6.60



- STANDARD MAGNETIC CATCHES
- SHUTTER BARS

- SLIDING DOOR EDGE PULLS

STANDARD MAGNETIC CATCHES

No. 323

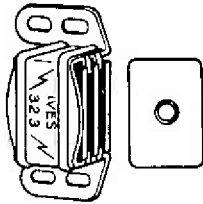

Aluminum Case
Triple Pole
Case size: 2 1/16" x 1 1/32" x 7/8"

No. 324

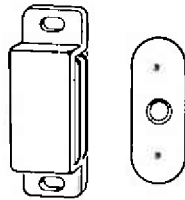

Plastic Case
Double Pole
Case size: 1 3/4" x 3/16" x 1/2"

No. 325

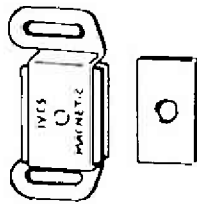

Aluminum Case
Double Pole
Case size: 2 1/16" x 1 1/8" x 5/8"

TRIPLE POLE

Unique case design fits any detail. Attractive aluminum case. Self aligning pole piece and magnet. Individually polybagged, 25 per box; with sheet metal screws.

- IV323A3 **3.50**
- IV323A92 **3.50**

DOUBLE POLE

Economy priced. High impact tan plastic case. Self aligning with angle strike. Individually polybagged, 50 per box; with sheet metal screws.

- IV324P69 Dark Bronze Plastic **1.20**

DOUBLE POLE

Unique case design fits any detail. Attractive aluminum case. Self aligning pole piece and magnet. Individually polybagged, 50 per box; with sheet metal screws.

- IV325A92 Aluminum **2.30**
- IV325A3 Polished Brass **2.30**

SHUTTER BAR

Nos. 30, 31

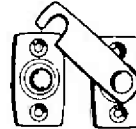

Solid Brass
Width: No. 30 1 3/4"
No. 31 2 1/4"

SHUTTER BAR KIT

Nos. K30, K31

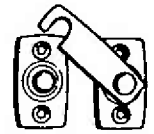

DOOR EDGE PULL

No. 230



Solid Brass
Includes 2 knobs
Width: No. K30 1 3/4"
No. K31 2 3/4"

SHUTTER BAR

Solid Brass
Size: 3 7/8" x 3/4" x 1 5/8"

The ideal shutter bar for bi-fold doors, shutters, etc. Contemporary design that accommodates narrow stiles. Rugged construction. Shoulder rivet ensures free swinging bar.

Machine Polished Brass. Individually polybagged with recessed oval head screws; 10 per box.

Code	Base	Hook Centers	Projection Centers	Finish	Price
IV30MB5	5/8" x 13/16"	1"	5/16"	Polished Brass	9.93
IV30MB26	5/8" x 1 3/16"	1"	5/16"	Polished Chrome	9.93
IV30MB26D	5/8" x 1 3/16"	1"	5/16"	Satin Chrome	9.93
IV31B5	7/8" x 1 1/2"	1 3/8"	7/16"	Antique Brass	24.20
IV31B3	7/8" x 1 1/2"	1 3/8"	7/16"	Polished Brass	20.10

CAFE SHUTTER-PACK

Complete hardware for a pair of cafe shutters. Includes one IV30MB3 Cafe Shutter Bar and two IV524B3-5/8" knobs with 500F2C special

IV30MB5	2 5/8" Knobs	15.22
---------	--------------	-------

SLIDING DOOR EDGE PULL

Rugged construction, quality made edge pull, finished to Ives' exacting specifications. Ideal for sliding doors. 3/4" width facilitates installation on thin doors. A spring automatically returns lever flush with plate.

Size: 3 7/8" x 3/4" x 1 5/8". Conforms with Federal Spec. No. 1861.

Hand Polished Wrought Brass plate and Extruded Brass lever. Individually polybagged with screws; 10 per box.

IV230B3	Polished Brass	10.90
IV230B5	Antique Brass	12.00
IV230B26	Bright Chrome	12.50
IV230B26D	Satin Chrome	12.50



AskYourLocksmith.com
Lancaster, Pennsylvania
Phone 717-392-6333

•ADJUSTITE CATCHES
•DOOR COORDINATORS

•DOOR GUARD
•DOOR CHIME

DOOR COORDINATORS FOR LABELED FIRE DOORS

Reversible, low friction, automatic coordinating devices for use on pairs of doors with or without astragal to prevent the active door from closing ahead of the inactive door. Used on labeled fire doors with Ives automatic flush bolts. Exclusive design incorporates unique cam tour and nylon coated strike, in conjunction with a nylon roller which reduces friction as well the critical requirements of installation.

Nylon coated strike plate enables single-screw, centerpoint mounting for simplified installation. The drop of the arm is muffled by shock absorbing polyurethane foam tape.

Solid Brass. One per box, with installation instruction, sheet metal and machine screws for door bracket, wood and machine screws for strike plate, and coordinator base.

Nos. 469, 469^{1/2}

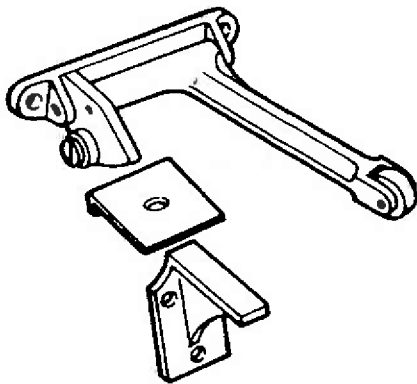

**Solid Brass
U.L. Listed
469 – 6^{3/4}" Projection
469^{1/2}" – 8^{1/2}" Projection**

COR7G (469)

No Astragal or Astragal on Active Door - Doors from 3'4" to 4'
Astragal on Inactive Door - Doors from 2'4" to 3'4"
Astragal on Both Doors - Doors from 2'4" to 2'10".

IVCOR7G-26D	Satin Chrome	56.00
-------------	--------------	-------

COR9G (469 1/2)

U.L. Listed for use as fire exit hardware. Conforms to Federal Spec. NO. 836.
Astragal on Inactive Door - Doors over 3'4"
Astragal on Both Doors - Doors over 2'10".

IVCOR9G-26D	Satin Chrome	64.00
-------------	--------------	-------

ADJUSTITE® CATCHES

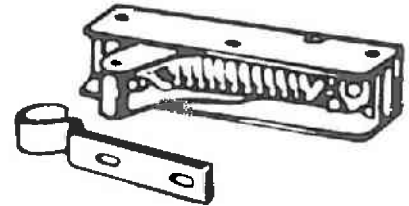

Low-cost, easy installation - no mortising necessary; no latch or lock required. Adjustable tension meets the requirements of most doors and casement windows. Prevents warping.

IV350 conforms to Federal Spec. NO. F1133.

Burnished Wrought Steel. Individually polybagged with template and screws; 10 per box.

ADJUSTITE®

Recommended for casement windows and large doors.

Code	Size	Pull Adjustment	Finish	Price
IV350f2C	4" x 1"	5 - 10lbs.	Zinc plated	13.70

DOOR CHIME

Shuttered control, one-way viewer. Solid Brass front plate with Ivory plastic chime case. 5 per box.

Front Plate: 4 9/16" x 2 1/2".

Chime Case: 6 1/16" x 2 3/4".

IV780B26D	Satin Chrome
IV780B3	Polished Brass

29⁴⁰

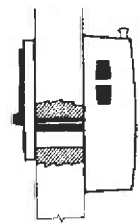

DOOR GUARD

Maintains security while door is slightly open. Solid Brass. Arm Length: 4 3/4".

IV482B26	Bright Chrome	28.40
IV482B26D	Satin Chrome	28.40
IV482B3	Polished Brass	25.80

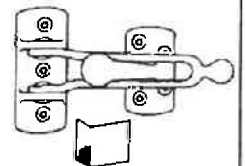



•ROLLER CATCHES
•Standard •Adjustable •Adjustable Tension

•CABINET CATCHES
•Roller •Elbow

•CUPBOARD LATCH
•BALL CATCHES

ELBOW CABINET CATCH

Used on the inactive side of a pair of cabinet doors. Plated dimensions: 1 3/8" x 5/8". Conforms to Federal Spec. No. 1075. Packed with screws.

Code	Material	Finish	Price
IV2A3	Aluminum	Bright Brass	3.30
IV2A92	Aluminum	Aluminum	3.30
IV2MB3	Brass	Polished Brass	10.60
IV2MB26	Brass	Bright Chrome	12.20
IV2MB26D	Brass	Satin Chrome	12.20

No. 2



ROLLER CATCH

Features heavy duty construction and a quiet-operation rubber roller. Surface applied; no mortising or boring required. Easy adjustment possible with the elongated slots on the case and strike.

Case Dimensions: 2" x 1 7/16". Strike: 1 3/4" x 3/4" Burnished Wrought Steel. Individually polybagged with screws and brads.

Solid Brass or Aluminum
Plate: 1 3/8" x 5/8"
Strike: 1 3/4" x 3/4"

No. 338

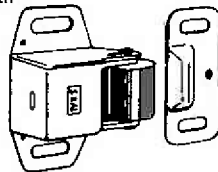

IV338F14
420
ea

IV338F3
420
ea

CUPBOARD TURN

A latch for cabinets and small doors. Case: 1 3/4" x 1 1/8". Strike: 1 3/4" x 3/8". Conforms to Federal Spec. No. 1082.

Hand Polished Cast Brass. Packed with screws.

IV540B3	Polished Brass	35.60
IV540B26	Polished Chrome	39.20
IV540B26D	Satin Chrome	39.20

Steel
Case: 2" x 1 1/8"

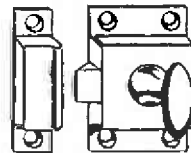

HEAVY DUTY ROLLER CATCHES FOR CABINET, WARDROBE AND INTERIOR DOORS

Narrow, 2 1/4" x 7/8" faceplate and 3/4" x 1 3/4" bore enable easy installation on thin doors. Smooth, positive latching action provided by powerful conical spring. Durable, uniform-action nylon roller. Quiet operation ensured by special rubber washer which cushions roller return.

Hand Polished Wrought Brass. Individually polybagged with sheet metal screws.

No. 335

No. 336

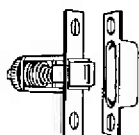
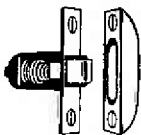

Solid Brass or Steel
Face Plate: 2 1/4" x 7/8"

Solid Brass or Steel
Face Plate: 2 1/4" x 7/8"

DUAL ADJUSTMENT BALL CATCHES

Ideal for louvered, bi-folding, accordion, wardrobe and service doors. The perfect catch to use with dummy trim. Dual adjustment provides door holding and clearance strength.

Faceplate: 2 1/8" x 1". Bore: 7/8" x 1 1/4".

Hand Polished Wrought Brass. Individually polybagged with screws.

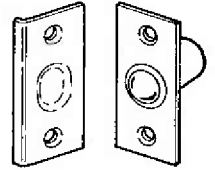

Solid Brass

Face Plate:

No. 345 - 1 1/2" x 3/4"

No. 346 - 2 1/8" x 1"

No. 347 - 2 1/8" x 1"

No. 346 - narrow strike - designed for use when action catch is mounted in the jamb.

DUAL ADJUSTMENTS

FEATURE

For clearance and tension. Makes it easy to compensate for swelling, shrinking, drafts and weight of doors.

- A. Free rolling ball insures smooth, positive and trouble-free action.
- B. Adjustable threaded barrel to compensate for various clearances of doors.
- C. Adjustable spring tension for any desired action.

FOR CATCH IN JAMB INSTALLATIONS

Code	Strike	Strike Lip	Finish	Price
IV346B3	2 1/8" x 1 1/16"	9/16" to center	Polished Brass	9.70
IV346B26D	2 1/8" x 1 1/16"	9/16" to center	Satin Chrome	11.20

FOR CATCH IN DOOR INSTALLATIONS

Code	Strike	Strike Lip	Finish	Price
IV347B3	2 1/8" x 1 3/8"	7/8" to center	Polished Brass	9.70
IV347B26D	2 1/8" x 3/8"	7/8" to center	Satin Chrome	11.20

ADJUSTABLE TO CLEARANCE ONLY

For use on cabinets and small interior doors.

Faceplate: 1 1/2" x 3/4". Bore: 9/16" x 7/8".

Code	Strike	Strike Lip	Finish	Price
IV345B3	1 1/2" x 25/32"	13/32" to center	Polished Brass	6.60
IV345B26D	1 1/2" x 25/32"	13/32" to center	Satin Chrome	7.60
IV345B5	1 1/2" x 25/32"	13/32" to center	Antique Brass	7.30

ROLLER CATCH

Full lip style strike simplified mortising.

Code	Strike	Strike Lip	Finish	Price
IV333B3	2 1/4" x 1 5/8"	1 3/16" to center	Polished Brass	7.35
IV333B26D	2 1/4" x 1 5/8"	1 3/16" to center	Satin Chrome	8.80
IV333B5	2 1/4" x 1 5/8"	1 3/16" to center	Antique Brass	8.80

ADJUSTABLE-TENSION ADJUSTABLE ROLLER CATCH

Full lip strike for simplified mortising.

Code	Strike	Strike Lip	Finish	Price
IV335B3	2 1/4" x 1 5/8"	1 3/16" to center	Polished Brass	11.30
IV335B26D	2 1/4" x 1 5/8"	1 3/16" to center	Satin Chrome	13.60
IV335B5	2 1/4" x 1 5/8"	1 3/16" to center	Antique Brass	13.60

ADJUSTABLE TENSION ADJUSTABLE ROLLER CATCH

Standard box type strike provides neat appearance.

Code	Strike	Strike Lip	Finish	Price
IV336B3	2 1/4" x 7/8"	1 1/8" to center	Polished Brass	10.40
IV336B26D	2 1/4" x 7/8"	1 1/8" to center	Satin Chrome	12.50
IV336B5	2 1/4" x 7/8"	1 1/8" to center	Antique Brass	13.60



- SASH LOCK
- WINDOW LOCKS
- CASEMENT ADJUSTER
- SASH FASTENER
- HOOKS

No. 4

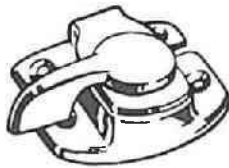

Solid Brass or Steel
"Jimmy Proof"
Base: 1 3/8" x 2 5/16"
Strike: 9/16" x 2 3/16"

Nos. 07, 9



No. 07- Solid Brass or Alum.
Base: 1 5/16" x 2 5/8"
Strike: 5/8" x 2 5/8"
No. 9- Solid Brass or Cast Iron
Base: 1 1/8" x 3"
Strike: 5/8" x 3"

SECURITY SASH LOCK

Spring lever pulls rails together to provide jimmy resistance and rattle-free fit. Hand Polished Wrought Brass. Individually polybagged with screws

IV4B3	Polished Brass	10.31
IV4B5	Antique Brass	12.44
IV4B26	Polished Chrome	12.44
IV4B26D	Satin Chrome	12.44
IV4F3	Steel, Brass Plated	3.85
IV4F26	Steel, Chrome Plated	4.55

SASH FASTENERS

World-renowned Crescent sash fastener pioneered by Ives. Designed low to the sash for superior strength and greater resistance to breakage. Vertical-horizontal camming action lifts sash up and pulls them together for a snug, non-rattling fit. The heavy gauge, top quality springs provide snappy wearing action.

Code	Material	Finish	Price
IV07A3	Aluminum	Bright Brass	2.10
IV07A92	Aluminum	Aluminum	1.91
IV07MB26	Brass	Bright Chrome	16.40
IV07MB26D	Brass	Satin Chrome	16.40
IV07MB3	Brass	Polished Brass	13.60
IV07MB5	Brass	Antique Brass	16.40



Solid Brass
Positive Locking
Length: 10", 12"

FRICTION CASEMENT ADJUSTER

With Positive Locking Device. 1" projection, 3/8" x 5/8" tube. Constant friction and the wing nut locking feature secures casement windows in any position.

Hand Polished Extruded Brass. Packed with screw.

Code	Length	Lbs. of Friction	Finish	Price
IV288B3-10	10"	15	Polished Brass	91.60
IV288B26D-12	12"	20	Satin Chrome	124.00

No. 405

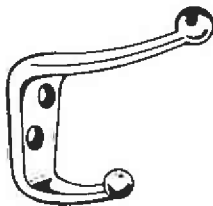

Aluminum
Projection: 2 1/2"

405 COAT AND HAT HOOK

Ideal for schools, dormitories and public areas. Engineered for extra strength and designed to withstand unusual strain.

Burnished Cast Aluminum. Individually polybagged with screw.

IV405A92	Aluminum	2.00
----------	----------	------

No. 571

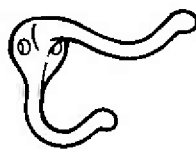

Solid Brass or Aluminum
Projection: 3"

571 ALL-PURPOSE HOOK

3" projection. Conforms to Federal Spec. No. 1172 (brass), No. 1172AL (aluminum). Individually polybagged with screws. Brass (10 per box); Aluminum (20 per box).

Code	Material	Finish	Price
IV571A3	Aluminum	Polished Brass	1.20
IV571A92	Aluminum	Aluminum	1.20
IV571A5	Aluminum	Antique Brass	1.40
IV571MB3	Brass	Polished Brass	6.60
IV571MB26	Brass	Bright Chrome	8.00
IV571MB26D	Brass	Satin Chrome	8.00
IV571MB5	Brass	Antique Brass	8.00
IV571MB10	Brass	Satin Bronze	6.60
IV571MB15A	Brass	Satin Nickel, Bl	8.30

No. 574

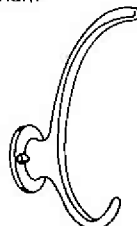

Solid Brass or Aluminum
Projection: 3 3/4"

COAT AND HAT HOOK

Decorative design for commercial and residential application. Height: 5". Projection: 3 3/4".

Base: 1 5/8" (H), 1 1/14" (W).
Solid Brass. Individually polybagged with screws;

IV574B3	Polished Brass	22.70
IV574B26	Bright Chrome	27.20

- HOOKS
- Wardrobe
- Utility
- Celing
- Garment
- Coat and Hat
- Multi-Purpose

COAT AND HAT HOOK

All purpose hook for large hats. Size: 7". Projection: 3 3/4". Solid Brass. Individually polybagged with screws.

No. 575

IV575B3	Polished Brass	22.90
IV575B5	Antique Brass	26.11
IV575B26	Polished Chrome	28.70
IV575B26D	Satin Chrome	28.70
IV575B15A	Satin Nickel Black	26.11
IV575A3	Alum. Brass Plated	4.00
IV575A92	Aluminum	4.00

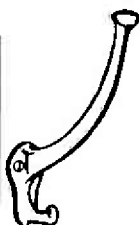

Aluminum
Projection: 3 3/4"

No. 572

572 ALL PURPOSE HOOK

Provides extra strength and durability. 3 1/16" projection. Machine Polished Cast Brass. Individually polybagged with screws.

IV572MB3	Polished Brass	9.10
IV572MB5	Antique Brass	9.98
IV572MB26	Polished Chrome	11.00
IV572MB26D	Satin Chrome	11.00
IV572A3	Alum. Brass Plated	3.30
IV572A92	Aluminum	3.30

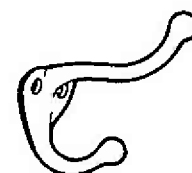

Solid Brass or Aluminum
Projection: 3 1/16"

No. 582



WARDROBE HOOK

All-purpose hook for areas with limited space. Base: 1 1/8" x 1 1/8". Projection: 1 1/8". Machine Polished Cast Brass. Individually polybagged with screws.

IV582MB3	Polished Brass	6.00
IV582MB26	Bright Chrome	7.20
IV582MB5	Antique Brass	6.60
IV582MB26D	Satin Chrome	7.20
IV582A3	Alum. Brass Plate	1.40
IV582A92	Aluminum	1.40

Solid Brass or Aluminum
Projection: 1 1/8"

No. 576

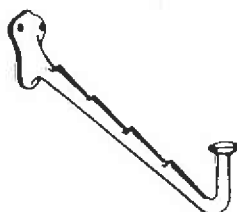

ALL PURPOSE GARMENT HOOK

Useful where additional storage space is needed. Solid Brass. Individually polybagged with screws

IV576B3	Polished Brass	19.71
IV576A3	Alum. Brass Plate	4.13
IV576B26	Polished Aluminum	20.60

Aluminum
Projection: 6 3/4"

UTILITY HOOK

All-purpose hook for utility areas. Base: 1 3/16" x 15/16". Projection: 1 1/8". Burnished Cast Aluminum. Packaged two per bag.

IV577A3	Alum. Brass Plated	1.91
IV577A14	Alum. Br. Nickel	2.04
IV577B26	Bright Chrome	4.71
IV577B26D	Satin Chrome	4.71
IV577B3	Polished Brass	3.84
IV577B5	Antique Brass	4.71



Aluminum
Projection: 1 1/8"

No. 577

ALL PURPOSE CEILING HOOK

Ideal for use in closets. Projection: 2 1/4". Machine Polished Cast Brass. Individually polybagged with screws.

IV580MB3	Polished Brass	10.10
IV580MB26D	Satin Chrome	12.10
IV580MB26	Polished Chrome	12.10

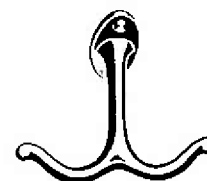

Solid Brass or Aluminum
Projection: 2 1/4"

No. 580

No. 581



WARDROBE HOOK

All-purpose hook for low-profile situations. Base: 1 1/8" x 1 1/8". Projection: 1 11/16". Individually polybagged with screws.

IV581MB3	Polished Brass	4.50
IV581MB26	Bright Chrome	5.30
IV581MB26D	Satin Chrome	5.30
IV581MB5	Antique Brass	5.30
IV581A3	Brass Plated Aluminum	1.30
IV581A92	Burnished Aluminum	1.30
IV581A-A-W	Aluminum - White	1.80
IV581A-A-BLK	Aluminum - Black	1.80

Solid Brass or Aluminum
Projection: 1 11/16"



AskYourLocksmith.com
Lancaster, Pennsylvania
Phone 717-392-6333

- DOOR PULL
- PUSH PLATE
- PULL PLATES

DOOR PULLS

Made from the finest architectural materials available. Carefully machined, polished and inspected before individually wrapped and packaged.

Packed with Ives standard type fasteners for 1 3/4" doors.

8102 DOOR PULLS

3/4" Round Bar Stock. 2 per pack.

Code	Center to Center	Finish	Price
IV8102-6B3	6"	Polished Brass	42.30
IV8102-6B26D	6"	Satin Chrome	38.90
IV8102-6PA28	6"	Satin Aluminum	17.70
IV8102-8B3	8"	Polished Brass	44.30
IV8102-8B26D	8"	Satin Chrome	40.90

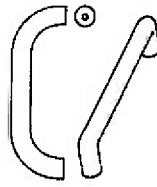

8103 DOOR PULLS

1" Round Bar Stock. 2 per pack.

Code	Center to Center	Finish	Price
IV8103-8B3	8"	Polished Brass	65.70
IV8103-8B26D	8"	Satin Chrome	68.60
IV8103-8PA28	8"	Satin Aluminum	22.90

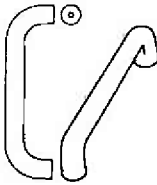

8112 DOOR PULLS

Standard Pull. Exposed Screws.
Mounting Surface: 1 7/8". 2 per pack

Code	Center to Center	Finish	Price
IV8112-5B3	5 1/4"	Polished Brass	37.10
IV8112-5B10	5 1/4"	Satin Bronze	41.60
IV8112-5B10B	5 1/4"	Dark Satin Bronze	41.60
IV8112-5B26D	5 1/5"	Satin Chrome	32.80

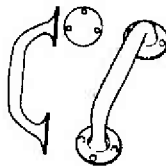

8113 DOOR PULLS

Stand Pull. Concealed Screw.
Mounting Surface: 1 7/8". 2 per pack.

Code	Center to Center	Finish	Price
IV8113-5B3	5 1/4"	Polished Brass	34.30
IV8113-5B10	5 1/4"	Satin Bronze	37.10
IV8113-5B10B	5 1/4"	Dark Satin Bronze	38.40
IV8113-5B26D	5 1/4"	Satin Chrome	32.60
IV8113-5PA28	5 1/4"	Satin Aluminum	17.60

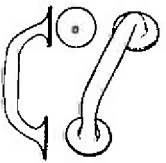

SERIES 8200 PUSH PLATES

Made from the finest architectural materials available. All plates meet ANSI A156.6 requirements for .050" thickness. Each plate is individually wrapped and packed with mounting screws. 10 per pack.

Code	Plate Size	Finish	Price
IV8200B3-3.5	3 1/2" x 15"	Polished Brass	18.00
IV8200B26D-3.5	3 1/2" x 15"	Satin Chrome	21.00
IV8200PA28-3.5	3 1/2" x 15"	Satin Aluminum	7.50
IV8200B3-4	4" x 16"	Polished Brass	21.00
IV8200S32D-4	4" x 16"	Satin Stainless Steel	12.00
IV8200PA28-4	4" x 16"	Satin Aluminum	8.00



SERIES 8300 PULL PLATES

Made from the finest architectural materials available. Each plate is individually wrapped and boxed with mounting screws.

8302 PULL PLATE

Code	Pull Size (C to C)	Plate Size	Finish	Price
IV8302-6B3	6"	3.5" x 15"	Polished Brass	53.00
IV8302-6B10B	6"	3.5" x 15"	Dark Satin Bronze	65.00
IV8302-6B26D	6"	3.5" x 15"	Satin Chrome	56.00
IV8302-6PA28	6"	3.5" x 15"	Satin Aluminum	25.00
IV8302-6S32D	6"	3.5" x 15"	Satin Stainless Steel	37.00
IV8302-8B3	8"	4" x 16"	Polished Brass	59.00
IV8302-8B26D	8"	4" x 16"	Satin Chrome	62.00
IV8302-8PA28	8"	4" x 16"	Satin Aluminum	25.00



8303 PULL PLATE

Code	Pull Size (C TO C)	Plate Size	Finish	Price
IV8303-8B3	8"	3.5" x 15"	Polished Brass	88.00
IV8303-8B26D	8"	3.5" x 15"	Satin Chrome	94.00
IV8303-8PA28	8"	3.5" x 15"	Satin Aluminum	31.00
IV8303-8B3	8"	4" x 16"	Polished Brass	91.00
IV8303-8B26D	8"	4" x 16"	Satin Chrome	97.00
IV8303-8PA28	8"	4" x 16"	Satin Aluminum	31.00



8305 PULL PLATE

Code	Pull Size (C to C)	Plate Size	Finish	Price
IV8305-6B3	6"	3.5" x 15"	Polished Brass	54.00
IV8305-6B26D	6"	3.5" x 15"	Satin Chrome	59.00
IV8305-6PA28	6"	3.5" x 15"	Satin Aluminum	24.00
IV8305-8B3	8"	4" x 16"	Polished Brass	65.00
IV8305-8B26D	8"	4" x 16"	Satin Chrome	66.00
IV8305-8PA28	8"	4" x 16"	Satin Aluminum	25.00



8314 PULL PLATE

Code	Pull Size (C to C)	Plate Size	Finish	Price
IV8314-5B3	5 1/4"	3.5" x 15"	Polished Brass	50.00
IV8314-5B26D	5 1/4"	3.5" x 15"	Satin Chrome	54.00
IV8314-5B3	5 1/4"	4" x 16"	Polished Brass	53.00
IV8314-5B26D	5 1/4"	4" x 16"	Satin Chrome	58.00
IV8314-5PA28	5 1/4"	4" x 16"	Satin Aluminum	27.98





- CRASH STOPS
- LETTER-SIZE MAIL SLOTT
- STORM DOOR LOCKS

KICK PLATES



All kickplates are .050 thick. They come with #6 x 5/8 Phillips Oval Head undercut stainless steel sheet metal screws, plated to match.

P/N	Size	Material & Finish	Price
IV8400B3-8X30	8 x 30	Brass, Polished Brass	74.40
IV8400PA28-8X30	8 x 30	Satin Aluminum	21.60
IV8400S32D-8X30	8 x 30	Satin Stainless Steel	33.60
IV8400B3-8X32	8 x 32	Brass, Polished Brass	79.36
IV8400PA28-8X32	8 x 32	Satin Aluminum	23.04
IV8400S32D-8X32	8 x 32	Satin Stainless Steel	35.84
IV8400B3-8X34	8 x 34	Brass, Polished Brass	84.32
IV8400PA28-8X34	8 x 34	Satin Aluminum	24.48
IV8400S32D-8X34	8 x 34	Satin Stainless Steel	38.08

MAGNETIC KICKPLATES

Residential Grade, .037 Thick
B505 Ultima Lifetime Finish

IV8400B505-8x34 8" x 34" 102.00

SLIDING DOOR PULL

No.990

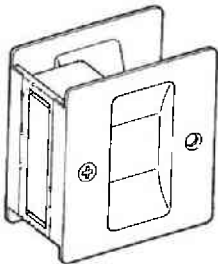

SLIDING DOOR LOCK

No.991

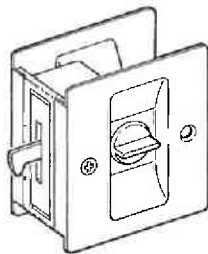

For doors 1 3/8" to 1 1/2" thick. Field reversible.
Clear pack, for retail display. 5/box

P/N	Description	Finish	Price
IV990B26	Sliding Door Pull	Polished Chrome	12.70
IV990B3	Sliding Door Pull	Polished Brass	9.20
IV990B5	Sliding Door Pull	Antique Brass	10.60
IV991B26	Sliding Door Privacy	Polished Chrome	14.70
IV991B3	Sliding Door Privacy	Polished Brass	12.80
IV991B5	Sliding Door Privacy	Antique Brass	14.70

WEATHER-TITE® LETTER BOX PLATES

Used on door exteriors for letter-sized mail. Conforms to U.S. Post Office specifications. Weather-Tite® construction features interlocking flap and frame for added weather protection.

IV623, IV624, and IV625 are supplied with a bronze spring which augments gravity to insure a tightly closed plate, and can be installed in vertical position. IV624B meets the code requirements of the city and county of San Francisco, para. 4306 E.I. for use on labeled corridor doors. Overall Size 10" x 3". Opening: 7 1/2" x 2".

Individually polybagged with template and screws.

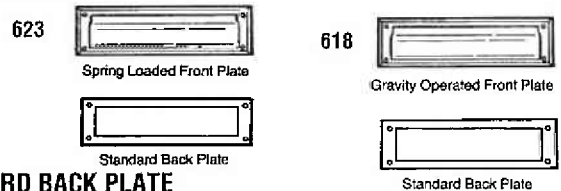

STANDARD BACK PLATE

Set consists of front plate and standard back plate.

Code	Material	Finish	Price
IV618A63	Aluminum	Brass Metallic Lacquer	23.60
IV623B3	Brass	Polished Brass	45.00
IV623B10B	Brass	Dark Satin Bronze	54.10
IV623B26D	Brass	Satin Chrome	54.10

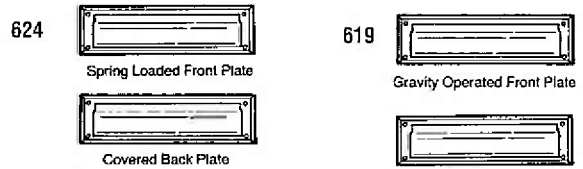

COVERED BACK PLATE

Set consists of front plate and gravity type covered back plate.

Code	Material	Finish	Price
IV624B3	Brass	Polished Brass	58.90
IV624B26D	Brass	Satin Chrome	70.70

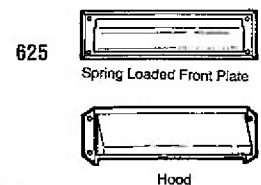

HOOD

Set Consists of front plate and hooded back plate.

Code	Material	Finish	Price
IV625B3	Brass	Polished Brass	66.50
IV625B26D	Brass	Satin Chrome	79.80

SLEEVE FOR 618/619/623/624/625

Made of stainless steel for 1 3/4" hollow core doors. One per box.

IV602
18⁹⁰

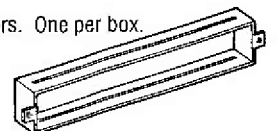



AskYourLocksmith.com
Lancaster, Pennsylvania
Phone 717-392-6333

- MAGAZINE-SIZE MAIL SLOT
- PUSH THROUGH MAIL SLOTS
- MAGNETIC MAGAZINE MAIL SLOT

WEATHER-TITE® MAGAZINE-SIZE LETTER BOX PLATES

Used on door exteriors for magazine-size mail. Conforms to U.S. Post Office specifications. Weather-Tite® construction features interlocking flap and frame for added weather protection.

Rugged construction; bronze spring augments gravity to insure a tightly closed plate. IV621B meets the code requirements of the city and county of San Francisco, para. 4306 E.I. for use on labeled corridor doors. Large Opening: 2".

Heavy-gauge Wrought Brass. Individually polybagged with screws and template.

STANDARD BACK PLATE

Set consists of spring front plate and standard back plate.

IV620B3	Polished Brass	100.30
IV620B5	Antique Brass	62.82
IV620B26D	Satin Chrome	75.40
IV620PA28	Polished Aluminum	37.00

COVERED BACK PLATE

Set consists of spring loaded front plate and gravity type covered back plate.

IV621B3	Polished Brass	86.70
IV621B5	Antique Brass	86.69
IV621B26D	Satin Chrome	104.00
IV621PA28	Polished Aluminum	51.20

HOOD

Set consists of spring loaded front plate and hooded back plate.

IV622B3	Polished Brass	97.50
IV622B26D	Satin Chrome	116.90

SLEEVE FOR 620/621/622

Made of stainless steel for 1 3/4" hollow core doors. One per box.

IV601
15³⁰

WEATHER-TITE® PUSH-THROUGH LETTER BOX PLATES

Used on door exteriors for letter-size mail. Conforms to U.S. Post Office specifications. Weather-Tite® construction features interlocking flap and frame for added weather protection. Bronze spring augments gravity to insure a tightly closed plate.

IV627B meets the code requirements of the city and county of San Francisco, para. 4306 E.I. for use on labeled corridor doors. IV626, IV627 and IV628 meet the code requirements of the City of New York, paragraph C-26-604.4(b).

Overall Size: 8 3/4" x 2 7/8".

Heavy-gauge Wrought Brass. Individually polybagged with screws and template.

STANDARD BACK PLATE

Set Consists of spring loaded front plate and standard back plate.

IV626B3	Polished Brass	73.80
IV626B10B	Satin Bronze, Dark Ox.	48.20
IV626B26D	Satin Chrome	48.20

COVERED BACK PLATE

Set consists of spring loaded front plate and gravity type covered back plate.

IV627B3	Polished Brass	54.60
IV627B5	Antique Brass	65.50
IV627B26D	Satin Chrome	65.50
IV627B10B	Satin Brass, Dark Oxidized	65.50
IV627B26	Polished Chrome	65.50

HOOD

Set consists of spring loaded front plate and hooded back plate.

IV628B3	Polished Brass	36.26
IV628B5	Antique Brass	41.44

SLEEVE FOR 626/627/628/629

Made of stainless steel for 1 3/4" hollow core doors. One per box.

IV600
12⁴⁰

MAGNETRACT™ MAGAZINE SIZE LETTER BOX PLATES

Ideal for exterior doors: the projection lip assures easy grasp even when wearing gloves. Magnetic inlays on the plate and flap augment gravity for a weather-tite fit and rattle-free installation.

Rugged construction; with massive extrusions for strength and weather resistance, coupled with an exclusive interlocked hinge design that holds the flap securely in place. Concealed pin permanently locks flap in plate; tamper proof when used with sex bolts.

Heavy-gauge Wrought Brass. Individually polybagged with screws and template.

STANDARD BACK PLATE

Set consists of magnetic front plate assembly and standard back plate.

Overall Size: 12 1/2" x 3 1/4". Plate Opening: 11" x 1 7/8".

IV650B10B	Dark Satin Bronze	128.90
IV650B3	Polished Brass	107.50
IV650B5	Antique Brass	128.90

COVERED BACK PLATE

Set consists of magnetic front plate assembly and gravity type covered back plate. Overall Size: 12 1/2" x 3 1/4". Plate Opening: 11" x 1 7/8".

IV651B3	Polished Brass	170.80
IV651B26D	Satin Chrome	204.90

HOOD

Set consists of magnetic front plate assembly and hooded back plate. Overall Size: 12 5/8" x 3 1/16". Plate Opening: 11" x 1 7/8".

IV652B3	Polished Brass	141.70
IV652B10B	Satin Bronze, Dark Oxidized	170.00
IV652B26D	Satin Chrome	170.00
IV652B15A	Satin Nickel, Blackened	176.80
IV652B26	Polished Chrome	170.00

SLEEVE FOR 650/651/52

Made of stainless steel for 1 3/4" hollow core doors. One per box.

IV603
18⁹⁰



- CASEMENT WINDOW OPERATORS
- HAND RAIL BRACKETS
- HYDRAULIC DOORS CLOSERS

Nos. 15



Wrought Steel Brackets,
w/ Steel Chain
Length: 22 3/4"
Spring Diameter: No. 11 9/16"

No. 115



Solid Brass Brackets
w/ Steel Chain
Lengths: 20 1/2", 25 1/2", 30 1/2"

No. 980



Solid Brass or Aluminum
Backset: 1 3/4"

15 CRASH STOP

Burnished Wrought Steel for Storm and Combination Doors. Rugged compression spring absorbs shock. Protects doors, hinges and glass from wind damage. Heavy steel fastening brackets. Conforms to Federal Spec. No. F1317.
 Overall Length: 29 3/4". Spring Diameter: 3/4".
 Zinc plated. Individually polybagged; 10 bags per box.

IV15F2C
10⁴⁰

115 CRASH STOPS

Hand Polished Cast Brass Staple Plates. Extra heavy duty; specially designed to protect full size exterior doors from wind and shock. With tear-resistant vinyl leatherette cover, heavy cast brass end brackets with four #10 screw holes, welded solid twist type steel chain, and heavy duty compression spring assembled to both ends of the chain and end brackets.
 Plate Size: 1 1/2" x 1 1/2". Packed with sheet metal screws; 5 per box.

Code	Overall Length	Recommended Door Width	Chain Finish	Price
IVCS115-25-26D	25 1/2"	36"	Satin Chrome	41.20
IVCS115-25-3	25 1/2"	36"	Polished Brass	34.30
IVCS115-30-26D	30 1/2"	42"	Satin Chrome	45.70
IVCS115-30-3	30 1/2"	42"	Polished Brass	37.90

STORM DOOR LATCH

Polished Wrought Brass for wood storm doors, 7/8" to 1 1/8" thick. Reversible; for right or left hand inswinging or outswinging doors. Security lock operates from inside rose. Safety strike assures latching - designed to compensate for air pressure build-up between doors.
 Backset: 1 3/4". Knob Diameter: 1 3/4". Rose Diameter: 1 7/8". Lever Length: 1 3/4". Lever Projection: 1 7/8". Case Diameter: 5/8". Case Length: 2 21/32". Conforms to Federal Spec. No. 1090S.
 Polished Brass. Individually boxed with screws, installation instructions and template.

IV980B26D
22⁸⁸

CASEMENT WINDOW OPERATIONS

For screened and non-screened doors. Rugged, smooth-working construction. Zinc die cast case and handle, steel arm and gear; Zinc plated.

No. 394

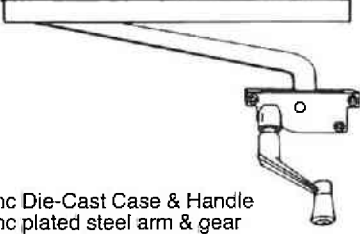

Zinc Die-Cast Case & Handle
Zinc plated steel arm & gear
Arm Length: 9"

FOR REPLACEMENT INSTALLATIONS ON WOOD SASH

Designed to accommodate all standard wood casement windows. 14" to 20" wide, employing built hinges.
 Case: 4" x 1 7/8". Length: 11 5/16". Conforms to Federal Spec. No. F1130. One per box, with 11 7/8" L. sash track, wood screws and instructions for mounting.

IV394Z65 Aluminum Metallic Lacquer
21⁹¹

059 HANDRAIL BRACKET

Base: 2 1/4" x 1 3/8". Base to Center of Rail: 2 7/16". Burnished Cast Aluminum. Individually polybagged with screws; 20 per box.

IV059A3	Brass Plated	2.90
IV059A92	Aluminum	2.90



Nos. 059, 59

59 HANDRAIL BRACKET

Base: 2 13/16" x 1 1/2". Base to Center of Rail: 2 3/4". Conforms to Federal Spec. No. 1064B. Machine Polished Cast Brass. Individually polybagged with screws; 10 per box.

IV59MB3	Polished Brass	17.30
IV59MB26D	Satin Chrome	19.90

No. 059: Solid Brass or Alum
Base: 2 1/4" x 1 3/8"
Base to center of rail: 2 7/16"
No. 59: Solid Brass or Alum.
Base: 2 13/16" x 1 1/2"
Base to center of rail: 2 3/4"



- FINGER PULLS
- SLIDING DOOR PULL
- DOOR PULL

SCREEN DOOR PULL

For use on screen doors, as window lift or drawer pull.
Burnished Cast Aluminum. Overall Length: 4 7/8". Projection: 1 5/32".
Packaged 25 per pack

IV25A3	Bright Brass	1.40
IV25A92	Aluminum	1.40

No. 25



Aluminum
Size: 4 7/8" C to C

BUILT-IN PRONGS
EXCLUSIVE IVES DESIGN—No Screws or Brads Needed
QUICK AND EASY TO INSTALL—Bore hole—insert pull, punch out prongs—that's all!
LOW IN COST—Yet IVES highest quality finish.
ATTRACTIVE—Neat convex style, good finger grip.

Showing Prongs Imbedded in Wood

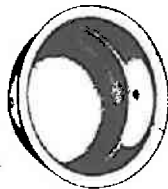

225

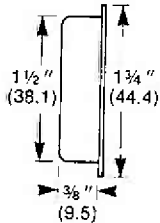

FLUSH SLIDING DOOR PULL

Ideal for louvered, bi-folding or sliding wardrobe doors. Deluxe quality heavy gauge wide flange - 2 1/8" bore. Hand Polished Wrought Brass. Individually polybagged with screws; 20 per box.

IV226B3	Polished Brass	5.30
IV226B5	Antique Brass	5.80
IV226B26	Bright Chrome	6.10
IV226B26D	Satin Chrome	6.10

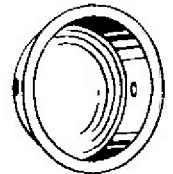

FINGER PULL

Used on sliding doors and doors requiring a flush mounted pull. 3/4" bore.

Burnished Wrought Brass.
Packed 4 per polybag; 25 bags per box.

IV218BB3	Polished Brass	2.00/BAG
----------	----------------	----------



FLUSH SLIDING DOOR PULL

Ideal for louvered, bi-folding or wardrobe doors. Deluxe quality heavy gauge wide flange - 1 1/2" bore. Hand Polished Wrought Brass. Individually polybagged with brads; 20 per box.

IV225B3	Polished Brass	3.30
IV225B5	Antique Brass	3.60
IV225B26	Bright Chrome	3.80
IV225B26D	Satin Chrome	3.80



FLUSH SLIDING DOOR PULLS

Used on sliding doors and doors which require a flush mounted pull. Hand Polished Wrought Brass. Individually polybagged with two escutcheon pins. 20 per box.

Code	Bore	Finish	Price
IV219B5	1 3/4"	Antique Brass	2.04
IV219B26	1 3/4"	Bright Chrome	3.50
IV219B26D	1 3/4"	Satin Chrome	3.50
IV220B3	2"	Polished Brass	3.00
IV220B5	2"	Antique Brass	3.01
IV220B26D	2"	Satin Chrome	3.50
IV220B26	2"	Bright Chrome	3.50
IV221B3	2 1/8"	Polished Brass	3.00
IV221B5	2 1/8"	Antique Brass	3.60
IV221B26	2 1/8"	Bright Chrome	3.50
IV221B26D	2 1/8"	Satin Chrome	3.50



SLIDING DOOR PULLS

For use on louvered, bi-fold or sliding wardrobe doors. With extra deep recess & reverse tapered grip. Size: 1 5/16" x 3 1/8".

Hand Polished Wrought Brass. Individually polybagged with screws; 20 per box.

IV222B3	Polished Brass	2.60
IV222B5	Antique Brass	3.00
IV222B26	Bright Chrome	3.00
IV222B26D	Satin Chrome	3.00

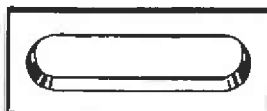

SLIDING DOOR PULLS

For use on louvered, bi-folding or sliding wardrobe doors. With reverse tapered grip. Size: 1 5/16" x 3 1/8".

Hand Polished Wrought Brass. Individually polybagged with screws; 10 per box.

IV222B3	Polished Brass	16.90
IV222B5	Antique Brass	19.40
IV222B26	Bright Chrome	19.40
IV222B26D	Satin Chrome	19.40

