

### Numeric Keypad

Provides authorization with a PIN code of variable length.

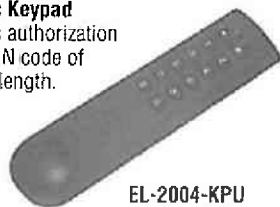

EL-2004-KPU  
**279<sup>00</sup>**

### Magstripe Card

Designed for secure confirmations with existing mag stripe cards, including credit cards.

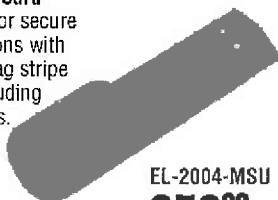

EL-2004-MSU  
**352<sup>00</sup>**

### Prox Reader

Just wave the card and enter.



EL-2004-PRU  
**543<sup>00</sup>**

Call for your specific application and pricing.

## eLock

CompX eLock is a highly engineered electronic lock with a motor-driven latch. Its uncompromising lock control electronics includes a non-volatile memory that stores 250 user/supervisor codes and audit trail. With optional LockView™ audit trail software, CompX eLock remembers 1500 access attempts. Programming is simple with numeric keypad or Windows™ based Lockview™ software.

### Magstripe/Keypad Dual System

Magstripe card and numeric keypad for dual control.



EL-2004-MSKP-U  
**356<sup>00</sup>**

### Prox Reader/Keypad Dual System

Prox reader and numeric keypad for dual control.

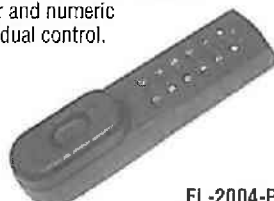

EL-2004-PRKP-U  
**546<sup>00</sup>**

### FEATURES

- Surface mounted
- Audit trail of last 1,500 access attempts with date, time, and user name
- Motor driven latching mechanism
- LED status indicators (red & green)
- "Jump Start" 9-volt battery power port
- Audible Alarm Bolt System
- Dual credential access available
- Compatible with 12 volt electric door strikes
- Low battery indicator
- 4AA battery pack mounts remotely (two year battery life). Alkaline batteries recommended- not included
- Audible Beeper
- Standard RJ 11 communications port

### CompX eLock OPTIONS

- Power Pack (120V or 230V)
- High decibel alarm box
- Dual latch control system
- LockView™ software
- Solenoid Latch
- Through door mounting available
- RJ11/ USB converter for LockView™ Windows™ software
- Electric Strike
- 5-Minute lockout after multiple invalid attempts
- Embedded Security Data:
  - Serial number
  - Two reset codes to delete supervisors and users
  - Pass code prevents unauthorized LockView™ use
  - User and supervisor codes (250)

## eLock w/Temperature Monitor

### The 1st and Only Product to Provide Security & Temperature Monitoring

The CompX eLock® with temperature monitoring is the only product that offers security and the ability to record temperature, complying with all **Joint Commission** requirements.

- Allows secure access using existing credentials and badges
- Use on refrigerators, freezers, warmers and more
- Easy to install, battery operated
- Programming can be done manually or through optional LockView Software®
- Monitors internal temperatures from -40° F to 122° F (-40° C to 50° C)
- Provides programmable audit trails - charts, graphs, reports, etc.
- Enabling/disabling audible alarm
- Contains dry contact for remote monitoring systems

### The eLock w/Temperature Monitor is available in 3 kits:

EL-KP-TEMP	971.00
Temp. Monitoring Refrigerator Kit - Keypad	
EL-MSKP-TEMP	1,092.00
Temp. Monitoring Refrigerator Kit - Magstripe/Keypad	
EL-PRKP-TEMP	1,260.00
Temp. Monitoring Refrigerator Kit - Proximity/Keypad	



## eLock For Appliances

Similar to the eLock with temperature monitoring, the eLock kit for appliances mounts externally and can be used in almost any application - pharmacies, nurse's stations, research labs... wherever access control and/or audit trail is needed.

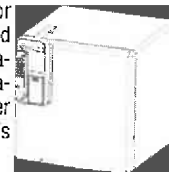

EL-KP-FRKIT	511.00
Refrigerator Kit - Numeric Keypad	
EL-MS-FRKIT	586.00
Refrigerator Kit - Magstripe Reader	
EL-MSKP-FRKIT	621.00
Refrigerator Kit - Magstripe/Keypad	
EL-PR-FRKIT	781.00
Refrigerator Kit - Proximity Reader; H/D	
EL-PRKP-FRKIT	815.00
Refrigerator Kit - Proximity/Keypad	

**SC ADVANTAGE**

SC Advantage cabinet locks can be masterkeyed to door hardware using the Schiage "C" keyway, providing the convenience of single-key operation.

Sizes: 1 1/8" and 1 3/8" cylinder sizes in bright brass or dull chrome finishes

Keying Options: Keyed different, keyed alike, master keyed to schedule

Zero Bitted: 5 pin standard, 6 pin option

Accepts other manufacturers' compatible cylinders.

C9003  
 C9011

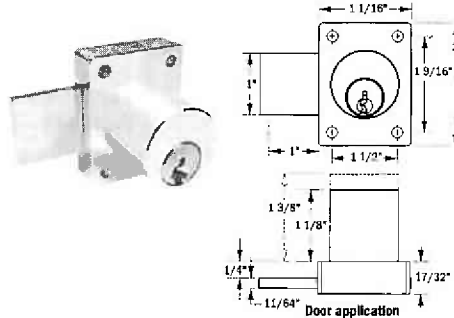

Code	Finish	Installation	Bolt Type	Cylinder Length	Bolt Travel
NAC9001-26D	Dull Chrome	Drawer	Dead	1 1/8"	1"
NAC9001-3	Polished Brass	Drawer	Dead	1 1/8"	1"
NAC9003-26D	Dull Chrome	Door	Dead	1 1/8"	1"
NAC9003-3	Polished Brass	Door	Dead	1 1/8"	1"

51<sup>15</sup>

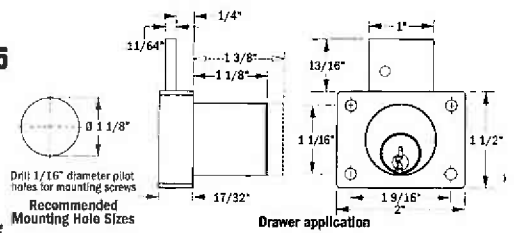

NAC9009-26D	Dull Chrome	Drawer	Dead	1 3/8"	1"
NAC9009-3	Polished Brass	Drawer	Dead	1 3/8"	1"
NAC9011-26D	Dull Chrome	Door	Dead	1 3/8"	1"
NAC9011-3	Polished Brass	Door	Dead	1 3/8"	1"

52<sup>25</sup>

Keying Alike Codes: 101, 102 and 0 bitted (non-bitted)

Packaging: Supplied with (2) keys, (2) strikes, (2) spacers and mounting screws. LC ("Less Cylinder") locks do not include keys.

**DUAL Access KEYLESS CAM LOCK**

- 10,000 possible combinations with key override
  - Replaces any standard cam lock to get instant keyless access
  - Retrofits into existing 3/4" wood or metal mounting holes - no need for drilling or modification
  - Small profile fits most door and drawers
  - Two access modes: combination or key
  - Combination secure - can only be changed with the proper key and current correct combination
  - Removable lock plug for easy rekeying
  - Master keying standard
  - Heavy duty die cast construction
- Available cylinder lengths: 7/8" & 1 3/8"

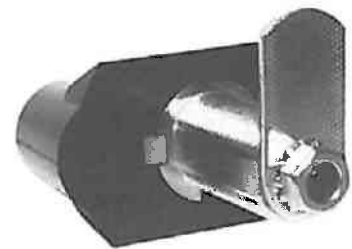

	NAD8030-19	NAD8031-19
Cylinder Length	7/8"	1 3/8"
Maximum Mat. Thick.	5/8"	1 1/8"
MKKA Codes*	3	3
MKKD Codes	60	60
Case Qty.	10	10
Key Blank	D8770	D8770
Plug Removal Key	D8771	D8771
Master Key	D8772	D8772
Price	33.99	33.99

\* Key Codes: DA108, DA120, DA124

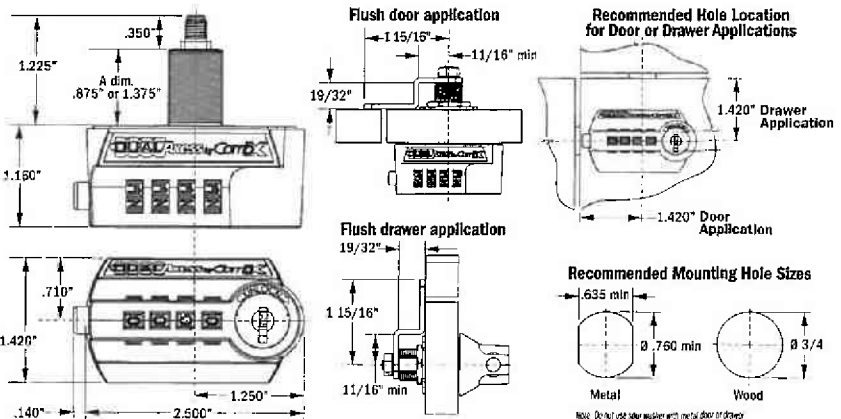

Note: Do not use other master with metal door or drawer

- CYLINDER CAM LOCKS
- Brass Pin Tumbler • Die Cast Pin Tumbler • Disc Tumbler

## BRASS PIN TUMBLER CYLINDER CAM LOCKS

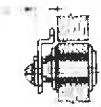

FLUSH

CB102  
CB106  
CB108



LIPPED/  
OVERLAY

CB103  
CB109



**Application** - For drawers, R.H. or L.H. door, NAC8103 and NAC8109 for lipped construction; the balance for flush application.

**Operation** - 90° cam turn; key removable in both locked and unlocked positions.

**Keying** - Will key together with all other NAC8100 series locks. Available Keyed Different (850 changes). Master Keyed Different GM (650 changes).

**Packaging** - 10 in a box. Supplied with two keys; trim washer, spur washer for wood; flat washer for metal; and two cams for all three applications.

**Key Blank** - D4291.

**MK 22<sup>60</sup> KD 20<sup>39</sup>**

## DISC TUMBLER FILE CABINET LOCKS

**Application** - Used internally on filing cabinets to gang lock drawers.

**Operation** - Key removable in locked position.

**Keying** - Keyed only to "Pundra" keyway, P141A when ordering KA.

**Packaging** - Supplied with two keys.

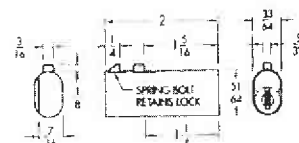
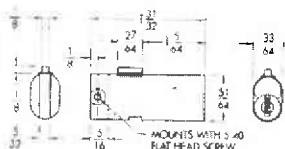

REPLACEMENT FOR  
"SHAW WALKER"



C8046



C8047

Code	Finish	Bolt Type	Bolt Travel	Price
NAC8046-26	Polished Chrome	Spring	1/8"	15.29
NAC8047-26	Polished Chrome	Spring	1/8"	39.63

Code	Finish	Type of Mounting	Cylinder Length	Maximum Material Thickness
NAC8101-26D	Dull Chrome	Lipped	15/16"	5/8"
NAC8101-4	Satin Brass	Lipped	15/16"	5/8"
NAC8102-26D	Dull Chrome	Flush	1 1/6"	3/4"
NAC8102-4	Satin Brass	Flush	1 1/6"	3/4"
NAC8103-26D	Dull Chrome	Lipped	1 3/16"	7/8"
NAC8103-4	Satin Brass	Lipped	1 3/16"	7/8"
NAC8106-26D	Dull Chrome	Flush	1 7/16"	1 1/8"
NAC8106-4	Satin Brass	Flush	1 7/16"	1 1/8"
NAC8108-26D	Dull Chrome	Flush	1 3/4"	1 3/8"
NAC8108-4	Satin Brass	Flush	1 3/4"	1 3/8"
NAC8109-26D	Dull Chrome	Lipped	1 3/4"	1 1/2"
NAC8109-4	Satin Brass	Lipped	1 3/4"	1 1/2"

## DISC TUMBLER CYLINDER CAM LOCKS

Locks furnished with  
straight cams assembled

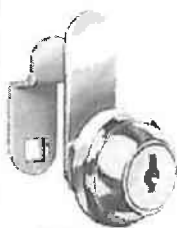

C8051



C8052, C8053  
C8054, C8055

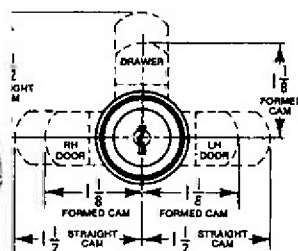

**Application** - For drawers, R.H. or L.H. doors with either lipped or flush construction.

**Operation** - 90° cam turn; key removable in both locked and unlocked positions.

**Keying** - Will key together with all other NAC8000 and NAC8700 series cabinet locks; excluding NAC8062. Available Keyed Alike (6 key codes), Keyed Different (200 changes) and Master Keyed Different F41A (200 changes).

**Packaging** - 25 in a box. Supplied with two keys; trim washer and spur washer for wood; and two cams.

**Key Blank** - D8785.

Code	Finish	Cylinder Length	Max. Mat. Thickness	Price
NAC8051-14A	Bright Nickel	7/16"	7/64"	6.36
NAC8051-3	Bright Brass	7/16"	7/64"	6.74
NAC8052-14A	Bright Nickel	5/8"	15/64"	6.36
NAC8052-3	Bright Brass	5/8"	15/64"	6.74
NAC8053-14A	Bright Nickel	1 3/16"	7/8"	6.36
NAC8053-3	Bright Brass	1 3/16"	7/8"	6.74
NAC8053-4G	Antique Brass	1 3/16"	7/8"	6.74
NAC8054-14A	Bright Nickel	1 5/16"	5/8"	6.36
NAC8055-14A	Bright Nickel	1 7/16"	1 1/8"	6.36
NAC8055-3	Bright Brass	1 7/16"	1 1/8"	6.74
NAC8055-4G	Antique Brass	1 7/16"	1 1/8"	6.74
NAC8060-14A	Bright Nickel	1 3/4"	1 7/16"	8.95
NAC8060-3	Bright Brass	1 3/4"	1 7/16"	9.28
NAC8060-4G	Antique Brass	1 3/4"	1 7/16"	9.28
NAC8073-14A	Bright Nickel	1 3/16"	7/8"	6.36
NAC8073-3	Bright Brass	1 3/16"	7/8"	6.74
NAC8073-4G	Antique Brass	1 3/16"	7/8"	6.74
NAC8075-14A	Bright Nickel	1 7/16"	1 1/8"	6.36
NAC8075-3	Bright Brass	1 7/16"	1 1/8"	6.74

- CYLINDER CAM LOCK
- Disc Tumbler

- PIN TUMBLER MAILBOX LOCKS
- Multi-Cam

**REVERSIBLE OPERATION  
 DISC TUMBLER CYLINDER CAM LOCK**

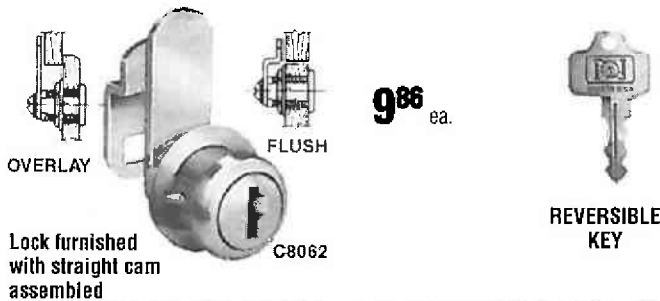

**Application** - For drawers, R.H. or L.H. doors with either lipped or flush construction.  
**Operation** - 90°dg cam turn; key removable in both locked and unlocked positions.  
**Keying** - Reversible key operation. Available Keyed Alike (1 key code-SX1) and Keyed different (100 changes).  
**Packaging** - 25 in a box. Supplied with two keys; spur washer for wood; and two cams  
**Key Blank** - D8777.

Code	Finish	Cylinder	Maximum Length
NAC8062-14A	Bright Nickel	7/8"	9/16"

**PIN TUMBLER "MULTI-CAM™" MAILBOX LOCKS**

**APPLICATION** - Interior architectural mail boxes used in apartments, condominiums, schools, lobbies. Nut mounted.  
**OPERATION** - 90° counter-clockwise cam turn to open. Key removable in locked position only.  
**KEYING** - Available keyed differently only (100 changing)  
**PACKAGING** - Supplied with selection of five cams, two keys, mounting nut and cam screw

Auth Electric  
 American Device  
 Florence Mfg  
 Bommer Industries  
 Miami-Carey  
 C8730  
 MOUNTING HOLE FOR ALL LOCKS  
 801

Code	Installation	Direction of Turn To Open
NAC8730	Architectural Mail Box Fronts	90° c/cw

**NEW POSTAL LOCKS**

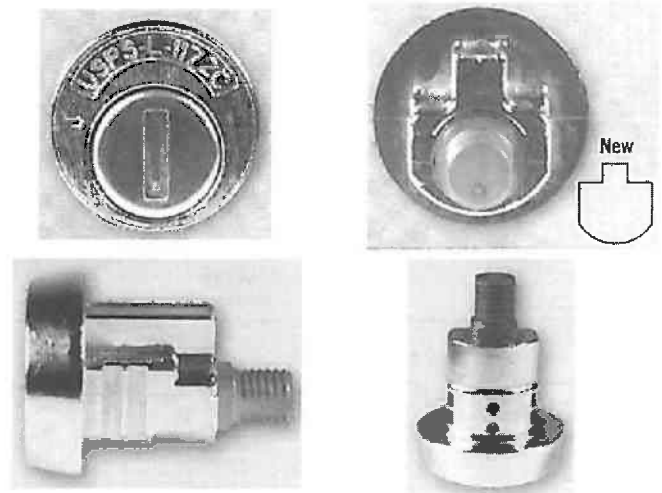

- Stainless Steel Plug
- 12° taper on cylinder head
- Now able to accommodate up to 3/16" stem
- Drain holes on the bottom of the cylinder
- Will include spring clip, mounting nut and (3) keys

C9100 operates clockwise  
 C9200 operates counter clockwise

C9100 ships w/o a cam for replacement of locks for new Standard 4C boxes shipped only to USPS

NAC9100	25/box	12.64 each
NAC9200	25/box	12.64 each

**NEW USPS KEYBLANKS**

- 2 keyways with 1000 changes each

NAD4300	Std. Keyway	1.28
NAD4301	Reverse Keyway	1.28

50/box



**APPLICATION** - Exterior pedestal-mounted neighborhood boxes. Has keyway dust shutter for lock protection. Clip mounted.  
**OPERATION** - 90° clockwise cam turn to open. Key removable in locked position.  
**KEYING** - Available keyed differently only (100 changes)  
**PACKAGING** - Supplied with a selection of five cams, three keys, mounting clip, cam nut and lock washer.

Auth Electric  
 Florence Mfg  
 Culler-Federal  
 Bommer Industries  
 C8735  
 Packed 25 per box.  
 Bright Nickel Finish.  
 Keyblank - D4292.

**NAC8735**  
 Door Of Pedestal  
 Mounted Neighborhood  
 Mailboxes

Direction to Open: 90° cw

1016

• MAILBOX LOCKS  
• Pin Tumbler **662** ea.

<p><b>NAC8710</b> Bommer Industries</p>	<p><b>NAC8711</b> Bommer Industries</p>	<p><b>802</b> <b>NAC8712</b> Bommer Industries</p>	<p><b>NAC8713</b> Auth Electric</p>
<p><b>NAC8714</b> American Device</p>	<p><b>NAC8715</b> Florence Mfg.</p>	<p><b>NAC8716</b> S.H. Couch</p>	<p><b>NAC8717</b> Nutone</p>
<p><b>NA8718</b> Cutler Mail Chute</p>	<p><b>NAC8719</b> Miami-Carey</p>	<p><b>802</b> <b>NAC8720</b> Dura Steel</p>	<p><b>NAC8721</b> Permbit XL-201</p>
<p><b>NAC8722</b> Dura Steel XL-202</p>	<p><b>NAC8723</b> Jensen General</p>	<p><b>NAC8724</b> Bommer Ind.</p>	<p><b>NAC8725</b> Cutler Federal</p>

• DOOR AND DRAWER LOCKS  
 • Pin Tumbler • Disc Tumbler

**PIN TUMBLER DOOR AND DRAWER LOCKS  
 "ADVANTAGE PLUS"**

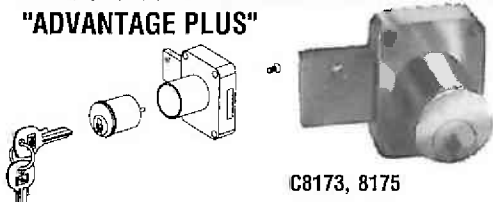

C8173, 8175

The PLUS feature allows you to remove the cylinder from our pin tumbler locks while the lock remains in place. Simply use a 5/64" allen wrench from the back to remove the cylinder and plug for re-keying.



C8177, 8178, 8179

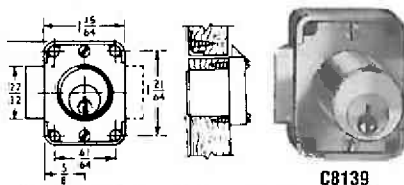

C8139

**Application** - Surface Mounted. For drawers, R.H. or L.H. doors. Requires 7/8" diameter hole for the cylinder.  
**Operation** - Key removable in both locked and unlocked positions; except NAC8139.  
**Keying** - Will key together with all other pin tumbler locks using D4291 key blank. Available Keyed Alike, 26D finish (4 key codes), 4 and 4G finish (2 key codes). All finishes available Keyed Different (850 changes) and Master Keyed Different GM 1(650 changes).  
**Packaging** - 10 in a box. Supplied with two keys, strike and mounting screw.  
**Key Blank** - D4291

**26<sup>61</sup>** ea.

Code	Finish	Installation	Bolt Type	Cylinder Length	Bolt Travel
NAC8173-26D	Dull Chrome	Door	Dead	7/8"	3/4"
NAC8173-4	Satin Brass	Door	Dead	7/8"	3/4"
NAC8173-4G	Antique Brass	Door	Dead	7/8"	3/4"
NAC8174-26D	Dull Chrome	Door	Dead	1 1/8"	3/4"
NAC8175-26D	Dull Chrome	Door	Dead	1 3/8"	3/4"
NAC8139-26D*	Dull Chrome	Door	Spring	3/4"	7/32"

NAC8178-26D	Dull Chrome	Drawer	Dead	7/8"	3/4"
NAC8178-4	Satin Brass	Drawer	Dead	7/8"	3/4"
NAC8178-4G	Antique Brass	Drawer	Dead	7/8"	3/4"
NAC8177-26D	Dull Chrome	Drawer	Dead	1 1/8"	3/4"
NAC8179-26D	Dull Chrome	Drawer	Dead	1 3/8"	3/4"
NAC8179-4	Satin Brass	Drawer	Dead	1 3/8"	3/4"

Packed 10 per box.

\* Key removable in locked position only (not "Advantage Plus") 39.16

**DISC TUMBLER DOOR DRAWER LOCKS**

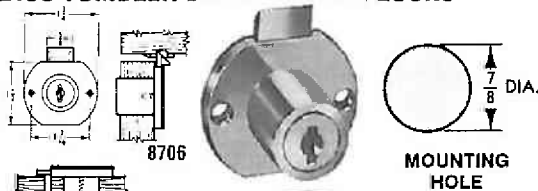

8706

MOUNTING HOLE  
 7/8" DIA.

8704

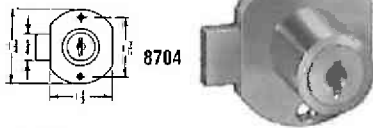

8703  
 8705

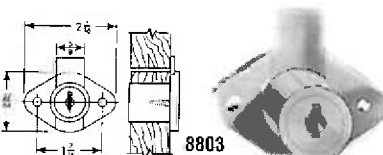

8803

**Application** - Surface Mounted. For drawers and doors. Requires 7/8" diameter hole for cylinder.  
**Operation** - Key removable in both locked and unlocked positions.  
**Keyed** - Will key together with all other NAC8000 and NAC8700 series locks; excluding NAC8802. Available Keyed Alike: NAC8703 and NAC8704(6 key codes), NAC8705 and NAC8706(3 key codes); Keyed Different; (200 changes), and Master Keyed different E41A(200 changes). NAC8706 is not stocked Master Keyed.  
**Packaging** - 25 per box. Supplied with two keys and mounting screws; with strike furnished with NAC8706 lock.  
**Finishes:** 14A - Bright Nickel; 3 - Bright Brass; 4G - Antique Brass  
**Key Blank** - D8785.

Code	Installation	Bolt Type	Cylinder Length	Bolt Travel	Price
NAC8703-14A	Drawer	Dead	15/16"	11/32"	8.76
NAC8703-3	Drawer	Dead	15/16"	11/32"	8.98
NAC8703-4G	Drawer	Dead	15/16"	11/32"	8.98

NAC8704-14A	Door	Dead	15/16"	11/32"	8.98
NAC8704-3	Door	Dead	15/16"	11/32"	9.25
NAC8704-4G	Door	Dead	15/16"	11/32"	9.25

NAC8705-14A	Drawer	Dead	1 3/16"	11/32"	9.29
NAC8705-3	Drawer	Dead	1 3/16"	11/32"	9.58
NAC8705-4G	Drawer	Dead	1 3/16"	11/32"	9.58

NAC8706-3	Drawer	Spring	15/16"	9/32"	11.07
-----------	--------	--------	--------	-------	-------

NAC8803-14A	Drawer	Dead	15/16"	11/32"	8.15
NAC8803-3	Drawer	Dead	15/16"	11/32"	8.40
NAC8803-4G	Drawer	Dead	15/16"	11/32"	8.40

## LEVER TUMBLER DOOR LOCK



C8422

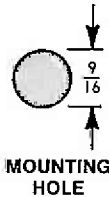
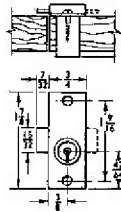

MOUNTING HOLE

**Application** - Surface Mounted. Hole required for cylinders. NAC88422 is used on doors with narrow stiles, such as display cases with wood frames.  
**Operation** - Key removable in both locked and unlocked positions.  
**Keying** - Keyed Alike.  
**Packaging** - 25 per box. Supplied with two keys, mounting screws.

Code	Installation	Bolt Type	Cylinder Length	Bolt Travel	Price
NAC8422-3	Door	Dead	7/8"	7/32"	15.46

## PIN TUMBLER DRAWER LOCKS

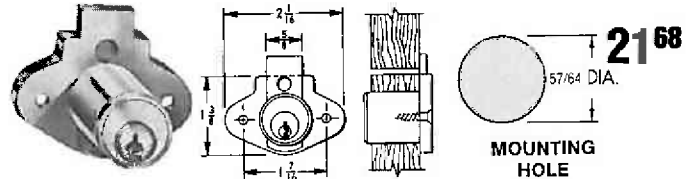

2168

MOUNTING HOLE

**Application** - Surface Mounted. For drawers. Requires 7/8" diameter hole for the cylinder.  
**Operation** - Cylinder removable from front of lock while lock remains in place. Key removable in both locked and unlocked positions.  
**Keying** - Will key together with all other NAC8100 series locks. Available Keyed Alike (4 key codes), Keyed Different (850 changes), and Master Keyed different GM (650 changes).  
**Packaging** - 10 in a box. Supplied with two keys and mounting screws.  
**Key Blank** - D4291.

Code	Finish	Installation	Bolt Type	Cylinder Length	Bolt Travel
NAC8163-26D	Dull Chrome	Drawer	Dead	15/16"	11/32"
NAC8163-4	Satin Brass	Drawer	Dead	15/16"	11/32"



CYLINDER REMOVAL KEY

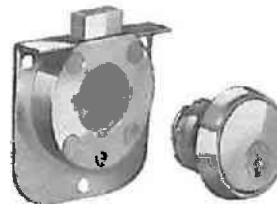

C8161

C8160

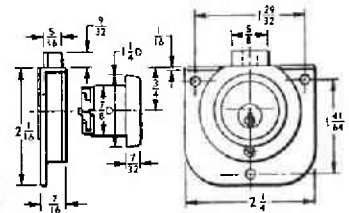

### HALF MORTISE DRAWER LOCK HOUSING

Has interchangeable cylinders.  
Packed 10 per box.  
NAC8161-26 18.70  
Bright Chrome

**PIN TUMBLER REMOVABLE CYLINDER**  
5-pin. Removable cylinder for NAC8161 housing. Packed 10 per box.  
NAC8160-26D 37.58  
Dull Chrome

## DISC TUMBLER DRAWER LOCKS

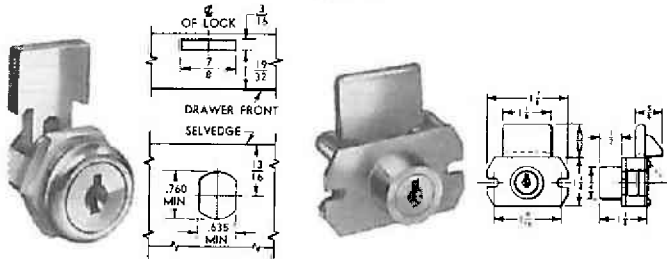

8701

MOUNTING HOLES

8896

**Application** - For drawers with NAC8701 for center drawers of metal desks. Fits special piercing of drawer and selvage. NAC8896 is a specific replacement lock.  
**Operation** - Key removable in both locked and unlocked positions.  
**Keying** - NAC8701 will key together with all other NAC8000 and NAC8700 series locks; excluding NAC8602. Available Keyed Alike; NAC8701 (6 key codes), NAC8896 (7 key code); Keyed Different; NAC8701(200 changes). NAC8896 (50 changes). NAC8701 is available Master Keyed different E41A(200 changes).  
**Packaging** - NAC8701, NAC8702 - 25 per box; NAC8896 - 10 box. Supplied with two keys and mounting nut for NAC8701s.  
**Key Blank** - D8785.

Code	Installation	Bolt Type	Cylinder Length	Bolt Travel	Price
NAC8701-14A	Center Drawer of Metal Desks	Insertable Dead Bolt	19/32"	11/32"	12.88
NAC8896-26D	Desk Drawer	Dead Bolt	1/2"	5/8"	31.91

- FILE CABINET
- PIN TUMBLER KNOB LOCKS

- PIN TUMBLER SLIDING DOOR
- PIN TUMBLER LOCK INSERTABLE BOLT

### PIN TUMBLER LOCK INSERTABLE BOLT

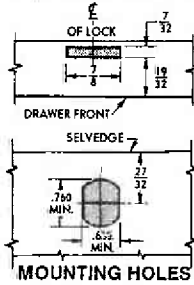

**MOUNTING HOLES**  
**Application** - For center drawers of desks. Fits special piercing of drawer front and selvage.  
**Operation** - Key removable in both locked and unlocked positions.  
**Keying** - Will key together with all other NAC8100 series locks. Available Keyed Alike(4 key codes), Keyed Different(8500 changes) and Master Keyed different GM(650 changes).  
**Packages** - 10 per box. Supplied with two keys and mounting nut.  
**Key blank** - D4291.

**NAC8137-BOLT**  
Replacement Bolt Only  
3.25



Code	Installation	Bolt Type	Cylinder Length	Bolt Travel
NAC8137-26D	Metal Drawer 1/4" Maximum Material Thickness	Insertable	19/32" Dead Bolt	7/16"

### PIN TUMBLER KNOB LOCKS

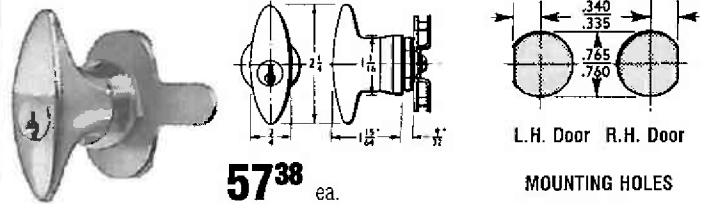

**Application** - For metal cabinet doors. Reversible for R.H. or L.H. application. Latch plate is for either 2 or 3-point latching.  
**Operation** - 90;dg turn ot open. Choice of key Operation.  
**Keying** - Will key together with all other NAC8100 locks. Available Keyed Alike (3 key codes) and Keyed Different (650 changes).  
**Packaging** - 10 in a box. Supplied with two keys and a latch plate.  
**Key Blank** - D4291.

Code	Key Operation	Maximum Material Thickness
NAC8154-26D	Key Removable in both Locked/Unlocked Positions	1/8"
NAC8155-26D	Key removable in Locked Position Only	1/8"

### PIN TUMBLER HALF MORTISE DRAWER LOCK

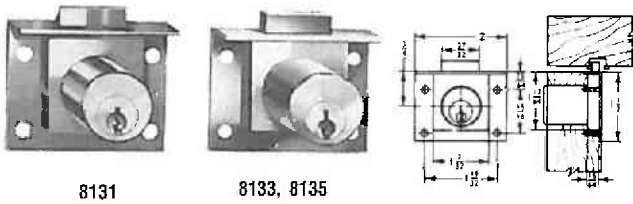

**39<sup>16</sup>** ea.

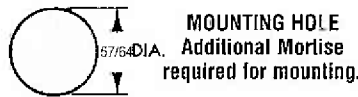

**Application** - For drawers. Half mortise type requires mortise for housing and 7/8" diameter hole for cylinder.  
**Operation** - Key removable in both locked and unlocked positions; except NAC8131.  
**Keying** - Will key together with all other NAC8100 series locks. Available Keyed Alike, 26D finish(4 key codes) and 4 finish(2 key codes). Both finishes available Key Different(8500 changes). 26D finish available Master Keyed different GM1(650 changes).  
**Packaging** - 10 per box. Supplied with two keys, strike and mounting screws.  
**Key Blank** - D4291.

Code	Installation	Bolt Type	Cylinder Length	Bolt Travel
NAC8131-26D	Drawer	Spring	7/8"	7/32"
NAC8131-4	Drawer	Spring	7/8"	7/32"
NAC8133-26D	Drawer	Dead	7/8"	1/4"
NAC8133-4	Drawer	Dead	7/8"	1/4"
NAC8135-26D	Drawer	Dead	1 1/8"	1/4"

### PIN TUMBLER SLIDING DOOR, FILE CABINET LOCKS

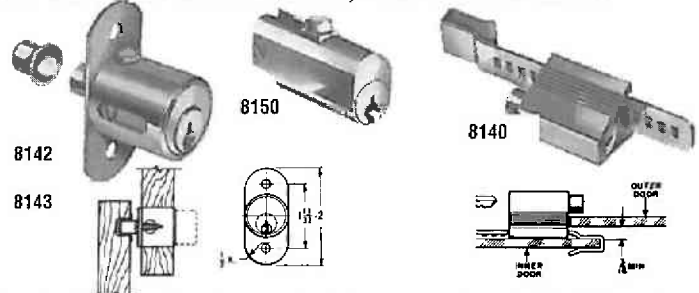

**Application** - For sliding doors, both of plate glass and wood, NAC 8142 requires a 7/8" diameter hole for cylinder. NAC8150 is used internally on filing cabinets to gang lock drawers.  
**Operation** - Key removable in locked position for NAC8140 and NAC8150. Key removable in both locked and unlocked positions for NAC8142.  
**Keying** - Will key together with all other NAC8100 series locks. Available Keyed Alike: NAC8140 and NAC8143(4 key codes), NAC8142(6 keys codes) and NAC815(5 key codes); Keyed Different; NAC8140 and NAC8142(25 changes), NAC8150(850 changes). NAC8142 is available Master Keyed different GM1(650 changes).  
**Packaging** - 10 per box. Supplied with two keys. NAC8142 is furnished with strike and mounting screws.  
**Key Blank** - D4291.

Code	Installation	Bolt Type	Cylinder Length	Bolt Travel	Price
NAC8140-26D	Plate Glass Sliding Doors	Internal Spring Bolt			35.58
NAC8142-26D	Sliding Doors	Plunger Bolt	1 1/8"	7/16"	38.75
NAC8142-4	Sliding Doors	Plunger Bolt	1 1/8"	7/16"	38.75
NAC8143-26D	Sliding Doors	Plunger Bolt	1 3/8"	7/16"	38.75
NAC8143-4	Sliding Doors	Plunger Bolt	1 3/8"	7/16"	38.75
NAC8150-26D	Filing Cabinet	Round Spring Action		7/8"	21.68



- DISC TUMBLER GANG LOCK
- DISC TUMBLER HANDLE LOCKS

## DISC TUMBLER GANG LOCK

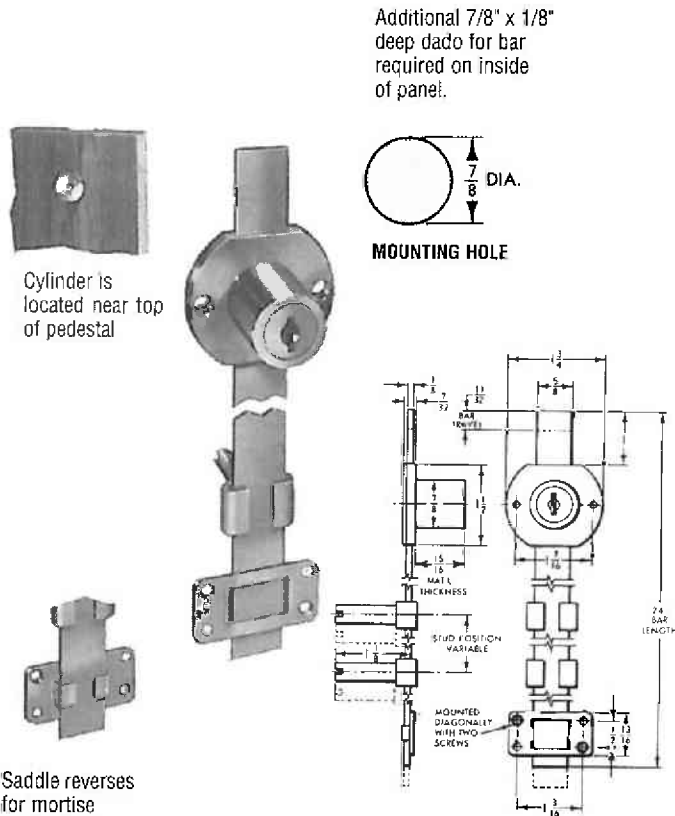

Cylinder is located near top of pedestal

Additional 7/8" x 1/8" deep dado for bar required on inside of panel.

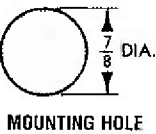

Saddle reverses for mortise application.

- NAD8090-14A Bright Nickel
- NAD8090-3 Bright Brass
- NAD8090-4G Antique Brass

**25<sup>09</sup>** ea.

**Application** - For locking drawers in desk pedestals and other multiple drawer applications. Requires a 7/8" diameter hole for cylinder, and a dado for bar, measuring 7/8" x 1/8" deep on inside of panel.

**Operation** - Key removable in both locked and unlocked positions. Turning the key locks all drawers simultaneously (drawers must be closed). Bar moves studs into notch in drawer or slide, preventing movement.

**Keying** - Will key together with all NAC8000 and NAC8700 series locks; excluding NAC8602. Available Keyed Alike (6 key codes), Keyed Different (200 changes), and Master Keyed different E41A (20 changes).

**Packaging** - 5 per box. Supplied with two keys, three each stud slides and locking studs, mounting hasp saddle and mounting screws.

**Installation** - Desk pedestals or similar multi-drawer conditions.

**Bolt Operation** - Dead locking.

**Cylinder Length** - 15/16"; **Bolt Travel** - 11/32".

**Key Blank** - D8785.

## DISC TUMBLER HANDLE LOCKS

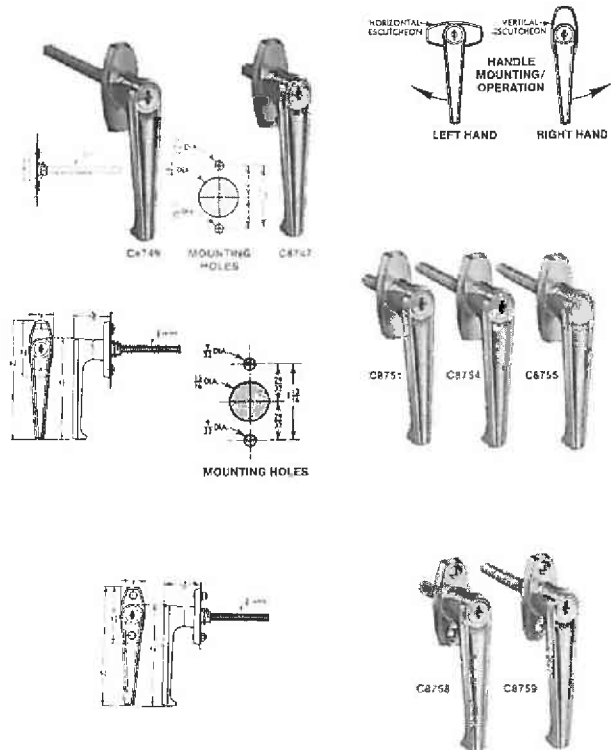

**Application** - For metal doors on lockers and cabinets, R.H. and L.H. Both NAC8756 and NAC8757 will fit spindles, except NAC8747 which has an 8-32 tapped end hole. NAC8749 will accept only the NAC8757 tongue. Spindle can be cut to fit special requirements.

**Operation** - Key removable in both locked and unlocked positions.

**Keying** - Will key together with all other NAC8000 and NAC8700 series locks; excluding NAC8062. Available Keyed Alike (3 key codes), except NAC8747 and NAC8749 (1 key code); and Keyed Different (200 changes).

**Direction of Turn to Open** - 90° c/w. **Key Blank** - D8785.

**Packaging** - 10 per box. Supplied with two keys and mounting bolts.

Code	Description	Mounting Type	Spindle Length	Price
NAC8747-26D	Locking	Rear	1" Square	25.11
NAC8749-26D	Locking	Rear	4" Square	25.11
NAC8751-26D	Locking	Rear	1" Threaded	25.11
NAC8754-26D	Locking	Rear	3" Threaded	25.11
NAC8755-26D	Non-locking	Rear	3" Threaded	22.45
NAC8758-26D	Locking	Escutcheon	1" Threaded	25.11
NAC8759-26D	Locking	Escutcheon	3" Threaded	25.11

- DISC TUMBLER
- GARAGE DOOR LOCKS
- Circuit Breaker Cabinet
- Handle Lock Parts
- Window Lock

**PARTS FOR DISC TUMBLER HANDLE LOCKS**

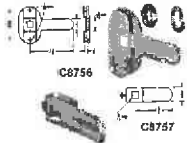

**SINGLE POINT LATCH TONGUE**  
 Side mounted, set screw. Zinc-plated.  
 25 per box.

**NAC8757-2C 3.97**

**THREE POINT LATCH PLATE WITH TONGUE**  
 Used with locking bars, Hex nuts with lock washers threaded on spindle. Zinc-plated.

**NAC8756-2C 5.08**

**GARAGE DOOR MECHANISM - LOCKING HANDLE**

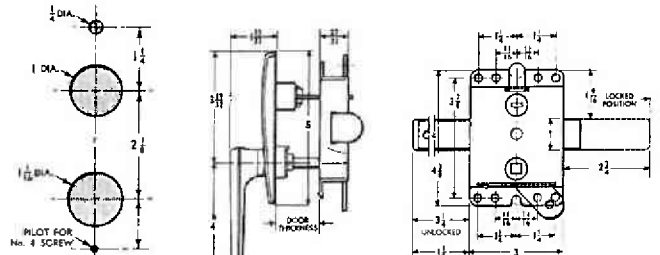

**MOUNTING HOLES FOR HANDLE**

**DISC TUMBLER DOOR & DRAWER LOCK w/flexafunction**

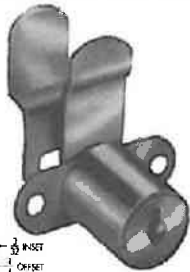

**Application** - For doors and drawers. Surface mounted. Requires a 3/4" dia. hole for cylinder.  
**Operation** - Choice of either 90° or 180° cam turn. Key removable in both positions.  
**Keying** - Will key together with all other disc tumbler locks using D8785 key blank. Masterkeying to E41A.  
**Packaging** - 25 per box. Supplied with two keys, two mounting screws, two formed cams and two stop washers. Cams unassembled.  
**Key Blank** - D8785.

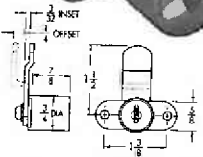

Code	Finish	Price
NAC8080-14A	Bright Nickel	7.98
NAC8080-3	Bright Brass	8.22
NAC8080-4G	Antique Brass	8.22

**DISC TUMBLER CIRCUIT BREAKER CABINET LOCK**

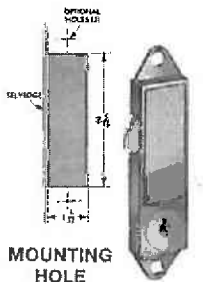

**Application** - For right handed metal door of electrical circuit breaker cabinets.  
**Operation** - Key removable in both locked and unlocked positions. Push plate operates spring bolt. Unlocked, push acts as spring latch.  
**Keying** - Keyed Alike only.  
**Packaging** - 10 per box. Supplied with two keys; no mounting hardware.  
**Type of Mounting** - R.H. Door.  
**Bolt Type** - Spring; Bolt Travel - 7/32".  
**Key Blank** - D8786.

**NAC8070-2C**  
 Zinc Plated

**19<sup>11</sup>**

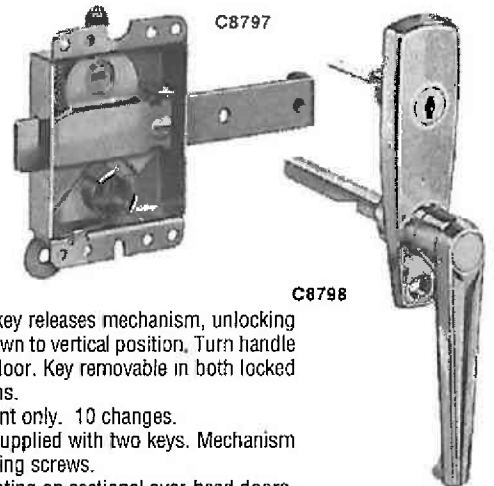
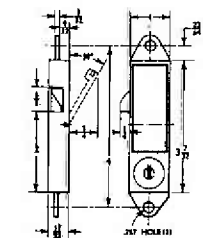

**Operation** - Turning key releases mechanism, unlocking door. Handle turns down to vertical position, Turn handle to horizontal to lock door. Key removable in both locked and unlocked positions.

**Keying** - Keyed different only. 10 changes.  
**Packaging** - Handle supplied with two keys. Mechanism furnished with mounting screws.

**Application** - For mounting on sectional over-head doors. Factory assembled for right hand mounting; mechanism installs at right side of door to lock into track (inside garage). Handle is installed over mechanism on outside of door. Handle replaces Overhead Door locking handles. Units can be reversed in field for left hand application.

Finishes: 2C - Zinc-plated; 26.  
 Packaging - 5 per box.  
 Key Blank - D8785.

Code	Installation	Operation	Description	Price
NAC8798-26	Outside Door over mechanism	Key releases mechanism-Handle locks mechanism	3 1/8" spindle	42.40
NAC8797-2C	Inside Door near track	Sliding Bolt locks into track	2 3/4" bolt mechanism	26.78

- FURNITURE LOCKS
- CHEST/LID LOCKS
- LOCKER LOCKS

## FURNITURE LOCKS

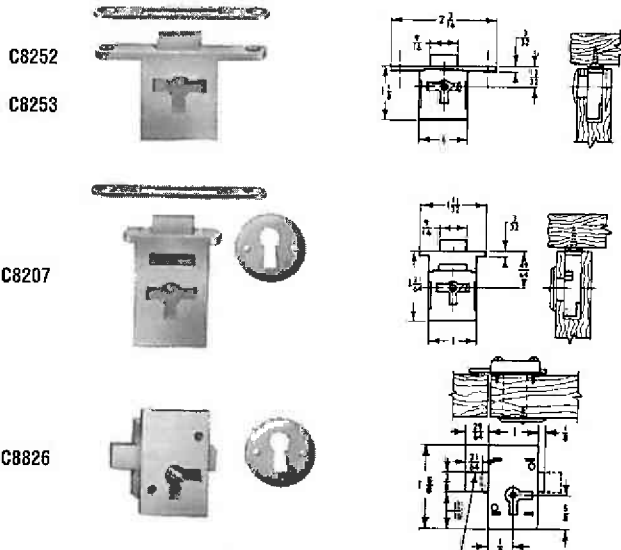

**Application** - Primarily for furniture and other fine cabinetry. NAC8826 is surface mounted and requires a hole for key entry. All other locks require full 11/32" x depth of lock. Additional mortising required for lock selvage plus hole for key entry.  
**Operation** - Key removable in both locked and unlocked positions.  
**Keying** - Keyed Alike.  
**Packaging** - 25 per box. Supplied with one key. All locks, except NAC8826, are supplied with strikes. Key hole escutcheons are packed with NAC8207 and NAC8826.  
**Key Blank** - D8890.

Code	Finish	Installation	Bolt Type	Bolt Travel	Price
NAC8207-3	Bright Brass	R.H. Door, Drawer, Full Mortise	Dead	3/16"	12.60
NAC8252-3	Bright Brass	R.H. Door, Drawer, Full Mortise	Dead	3/16"	10.82
NAC8253-3	Bright Brass	L.H. Door, Full Mortise	Dead	3/16"	10.82
NAC8826-3	Bright Brass	Door/Drawer, Surface Mounted	Dead	21/64"	7.89

## CHEST/LID LOCKS

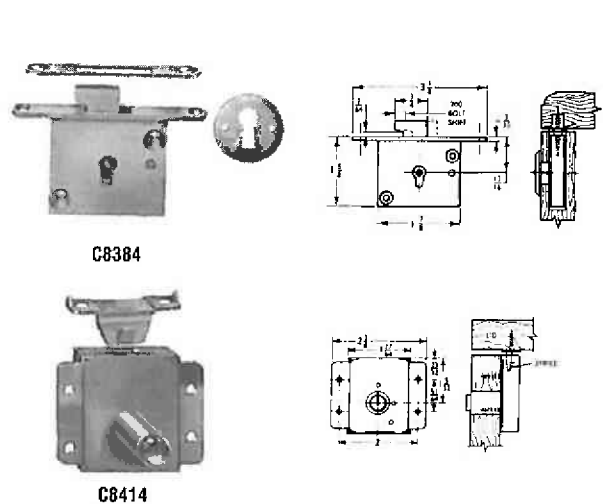

**Application** - Lid locks for cedar chests and other lid locking requirements. NAC8412 is surface mounted and requires a 9/16" diameter hole for the cylinder. NAC8384 requires 11/32" wide x depth of lock full mortise, plus mortise for selvage, plus a hole for key entry.  
**Operation** - Key removable in both locked and unlocked positions. C8412 uses pushbutton to release lid when lock is used as a latch to keep lid closed, but not locked.  
**Keying** - Keyed Alike.  
**Packaging** - 25 per box. Supplied with one key. Appropriate strikes and mounting screws are supplied with locks; additional keyhole escutcheon furnished with NAC8384.  
**Key Blank** - NAC8384: D8890.  
 NAC8412: D8191.

Code	Finish	Installation	Bolt Type	Cylinder Length	Price
NAC8384-3	Bright Brass	Chest, Lid Full Mortise	Hook		15.86
NAC8414-4G	Antique Brass	Chest, Lid Surface Mounted	Internal Engages Strike	7/8"	18.79

## "THE ADVANTAGE PLUS" Pin Tumbler Door and Drawer Cam Locks

The locks are fastened in place with two screws for easy installation. Re-keying or servicing is accomplished by removing the cam retaining screw and cam. Use a 5/64" allen wrench to remove the plug cylinder assembly. The mounting plate remains installed on the cabinet. Re-key as required and reinstall cylinder plug assembly on mounting plate.

Key blank: D4291. Satin Chrome Finish. Available master keyed, KD and KA.

**APPLICATION**- For drawer, R.H. or L.H. doors. C8183 assembled for door function. C8188 assembled for drawer function.

**OPERATION**-90° cam turn, key removable in both locked and unlocked positions.

**KEYING**-Will key together with all other pin tumbler locks using D4291 key blank, except mailbox locks. See table for available keying. Masterkeying to GM1.

**PACKAGING**-Supplied with two keys, extra backplate, two cams and two mounting screws. If trim ring is required, order C2017 separately.  
 Note: If formed cam is required, order C7113 or C7116.

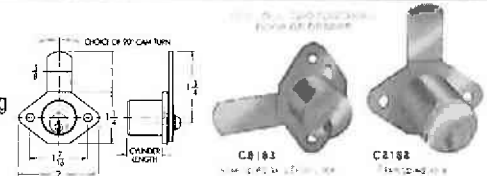

21<sup>62</sup>

P/N	Mounting	Cylinder Length	Maximum Mat. Thickness	Qty/Case
NAC8183-26D	Flush	7/8"	7/8"	10
NAC8188-26D	Flush	1 3/8"	1 3/8"	10

- PIN TUMBLER CAMS
- PIN KEYING KITS
- COOLER LOCKING HANDLE AND PLUGS

### COOLER LOCKING HANDLE REPLACEMENT PLUGS

**Operation** - Key removable in both locked and unlocked positions. Handle may be used as a latch until locked by key.

**Keying** - Keyed Alike to XC-3.

**Packaging** - NAC8764, NAC8763, NAC8762 - 25 per box. N/A and NAC8763 plugs are supplied with two keys and specific retainer. NAC8764 plug is supplied with two keys, retainer/stop and screw.

Bright Chrome finish, **Key Blank** - D8780.

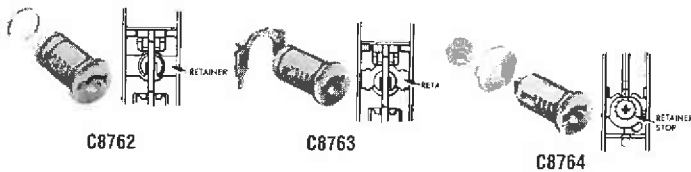

Code	Installation	Bolt Type	Price
NAC8762-26	Early models, N.L. 59-1105 handles		12.51
NAC8763-26	N.L. 59-1105 handles		12.51
NAC8764-26	Current NAC8765 handles		12.51

### SCREWDRIVER CAM LATCH

**Application:** For drawers or doors that do not require a key for locking

**Operation:** flexafunction™ feature provides choice of 90° or 180° cam turn. Cams are double punched for flexibility in mounting latch.

**Packaging:** Supplied with two cams, two stop washers, spur washer and mounting nut.



**525**

P/N	Mounting	Cylinder Length	Maximum Mat. Thickness	Qty/Case
NAC8065-14A	Lipped, Flush or Overlay	5/8"	1/4"	25

### PIN TUMBLER CAM

Cams for pin tumbler cylinder cam locks. All cams have dual application, see table below.

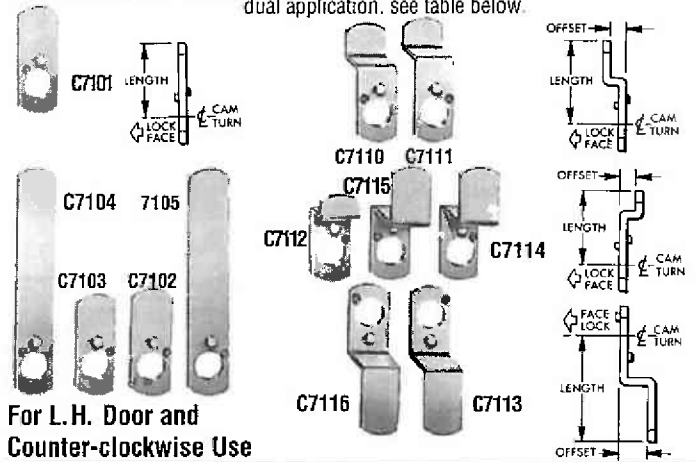

For L.H. Door and Counter-clockwise Use

Code	Description	Length	Price/Ea.
NAC7102-2C	Straight Cam	1 1/4"	1.20
NAC7103-2C	Straight Cam	1 1/8"	1.20
NAC7105-2C	Straight Cam	3"	1.38

For R.H. Door and Counter-clockwise Use Packed 20 per bag. Zinc-Plated

Code	Description	Length	Price/Ea.
NAC7101-2C	Straight Cam	1 1/4"	1.20
NAC7104-2C	Straight Cam	3"	1.38
NAC7115-2C	Double Formed Cam	1 5/8"	1.72

L.H.

Code	Description	Length	Price/Ea.
NAC7111-2C	Double Formed Cam	1 1/4"	1.72
NAC7112-2C	Double Formed Cam	1 1/8"	1.72
NAC7114-2C	Double Formed Cam	1 5/8"	1.72

Code	Description	Length	Price/Ea.
NAC7110-2C	Double Formed Cam	1 1/4"	1.72
NAC7113-2C	Double Formed Cam	1 5/8"	1.72
NAC7116-2C	Double Formed Cam	1 5/8"	1.72

### PIN KEYING KITS



### PIN TUMBLER KEYING KIT

- 100 ea. 1, 2, 3 and 4 Drivers
- 100 ea. 0, 1, 2, 3, 4, 5, 6, 7, 8, and 9 Tumblers
- 250 Tumbler Springs
- 100 Tumbler Retainers
- 50 ea. C3735 and C3738 Plug Retainers

NAV70P-1  
**112<sup>71</sup>**

### PIN TUMBLER MASTERKEYING KIT

- 100 ea. 2, 3, 4, 5, 6, 7 and 8 Master Drivers

NAV70P-2  
**32<sup>24</sup>**



### DISC TUMBLER KEYING KIT

- 100 ea. 00, 22, 44, and 66 Tumblers
- 250 Tumbler Springs

NAV71D-3  
**24<sup>82</sup>**

### DISC TUMBLER MASTERKEYING KIT

- 100 ea. 02, 04, 06, 24, 26, 40, 42, 46, 60, 62 and 64 Tumblers
- 250 Tumbler Springs

NAV71D-4  
**49<sup>25</sup>**

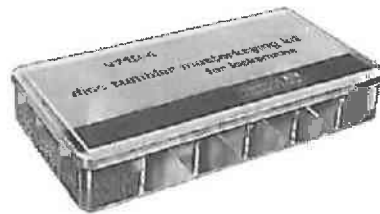

## DISC TUMBLER CAMS

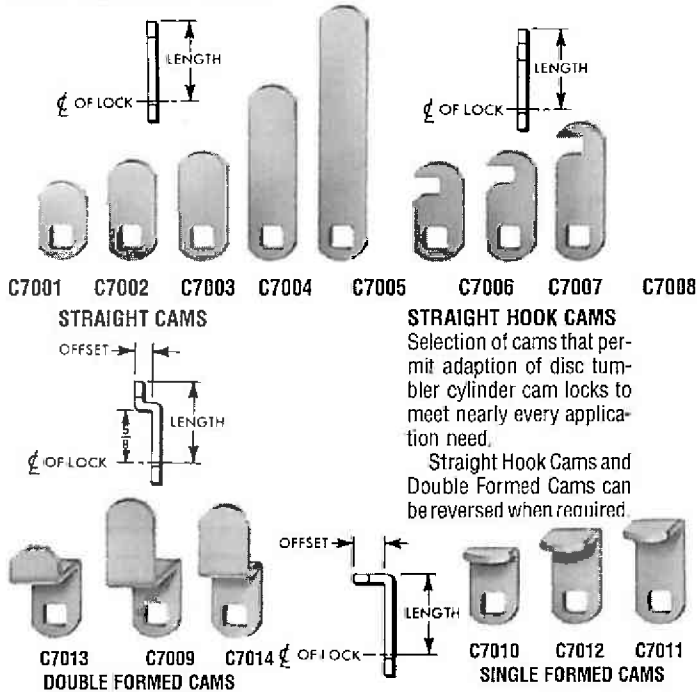

Code	Description	Length	Price/ea
NAC7001-2C	Straight Cam	3/4"	1.02
NAC7002-2C	Straight Cam	1"	1.02
NAC7004-2C	Straight Cam	2"	1.07
NAC7005-2C	Straight Cam	3"	1.15
NAC7003-2C	Straight Cam	1 1/8"	1.02
NAC7008-2C	Straight Hooked Cam	1 1/2"	1.22
NAC7007-2C	Straight Hooked Cam	1 1/8"	1.22
NAC7006-2C	Straight Hooked Cam	1"	1.22
NAC7009-2C	Double Formed Cam	1 3/4"	1.46
NAC7013-2C	Double Formed Cam	1 1/8"	1.46
NAC7011-2C	Single Formed Cam	1 7/8"	1.46
NAC7012-2C	Single Formed Cam	1"	1.46
NAC7010-2C	Single Formed Cam	5/8"	1.46
NAC7014-2C	Double Formed Cam	1 5/8"	1.46

Zinc-Plated. 25 per Bag.

## KEYS

Die Cast • Packed 50 per carton

### FREEZER LOCK KEYS

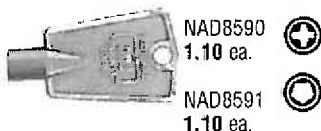

### WARDER BARREL KEY

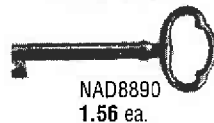

## ORIGINAL PIN TUMBLER KEYBLANKS

Brass • Packed 50 per carton

### PIN TUMBLER BLANKS



1.12 ea.

### 4 PIN TUMBLER BLANK

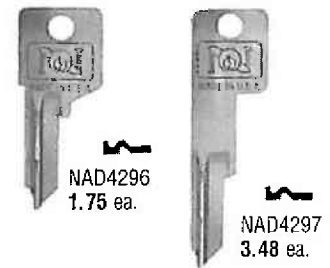

### IDENTIFYING KEY BLANKS

Blanks are listed with related actual size cross section. Sight down the end of the blank to identify the cross section or profile.



### 5 PIN TUMBLER BLANK



## ORIGINAL DISC TUMBLER KEYBLANKS

Brass • Packed 50 per carton

### 4 DISC TUMBLER BLANKS



1.03 ea.

### 5 DISC TUMBLER BLANKS



1.03 ea.

### 6 DISC TUMBLER



1.03 ea.

### 5 or 6 DISC TUMBLER REVERSIBLE KEY BLANKS

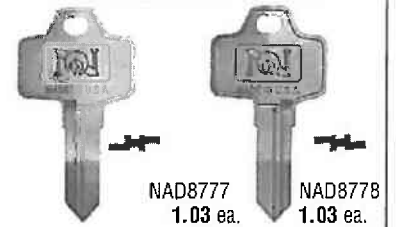

- KEYBLANKS
- CODE BOOKS

- DISC TUMBLER SLIDING DOOR

**ORIGINAL LEVER TUMBLER KEYBLANKS**

Packed 50 per carton

**FLAT LEVER TUMBLER BLANKS**



NAD8191  
Steel  
60¢ ea.

NAD8192  
Steel  
83¢ ea.

NAD8193  
Steel  
2.53 ea.

**PARACENTRIC LEVER TUMBLER BLANKS**



NAD8490  
Brass  
2.63 ea.

NAD8491  
Brass  
4.38 ea.

**DISC TUMBLER SLIDING DOOR LOCKS**

**Application** - For wood sliding doors. Requires a 7/8" diameter hole in front door for cylinder.

**Operation** - 9C8042; Push in cylinder, key turn engages bolt behind strike. C8043; Pushing in cylinder locks doors. Key removable in both locked and unlocked positions.

**Keying** - Will key together with all other disc tumbler locks using D8785 key blank.

**Packaging** - Supplied with two keys, strike and mounting screws.

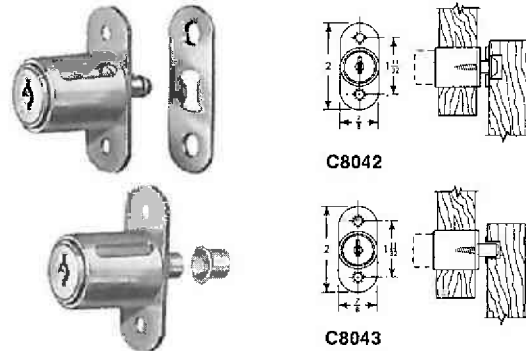

C8042

C8043

Code	Installation	Cylinder Type	Bolt Length	Bolt Travel	Price
NAC8042-26D	Sliding Doors	90° Turn Hook	7/8"	7/16"	32.25
NAC8043-26D	Sliding Doors	Plunger	1"	7/16"	17.20

**ORIGINAL MASTER KEYS**

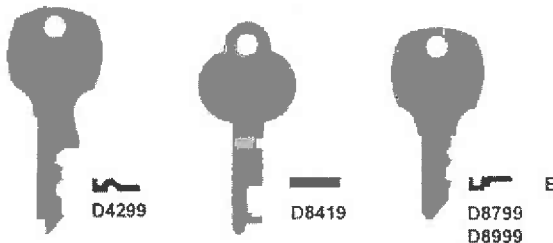

D4299

D8419

D8799  
D8999

P/N	Description	Material	Price
NAD4299	Pin Tumbler GM! Master Key	Brass	3.12
NAD8419	Lever Tumbler 5LM Flat Master Key	Steel	3.12
NAD8799	Disc Tumbler E41A Master Key	Brass	3.12
NAD8999	Disc Tumbler E13A Master Key	Brass	3.12

**KEY CODE BOOKS**

**D8001 Pin Tumbler Key Codes** - Includes the most popular National key codes: GM1 series, GM2 series, GM2A series, GM300 series, GM600 series and GM700 series.

NAD8001  
**6<sup>49</sup>**



D8001



D8002

NAD8002  
**3<sup>24</sup>**

**D8002 Disc Tumbler and Lever Tumbler Key Codes** - Includes the most popular National key codes: standard 4 tumbler series, standard 5 tumbler series, standard 6 tumbler series, 5 tumbler prefix RD series, 5 tumbler prefix GF series, 5 tumbler prefix SK and KS series, 6 tumbler prefix SK and KS series and 5 lever tumbler series 8LLT.