

•BEVEL PLATES

•MORTISE LOCK TRIMS

ESCUTCHEONS - SOLID BRASS

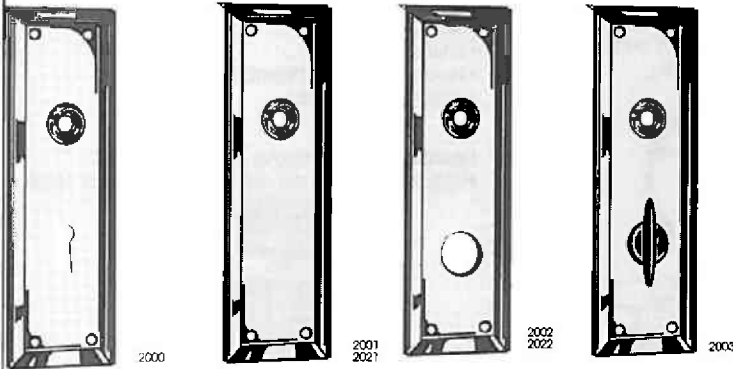

**BROAD BEVEL PLATE**

Solid Brass Traditional • 7" x 2 1/4"

KNOB BEARING AND KEY SLOT 12/box  
PG2000-3

**10<sup>56</sup>**

KNOB BEARING ONLY 12/box  
PG2001-3

**9<sup>33</sup>**

KNOB BEARING AND CYLINDER HOLE 12/box

Std. distance between holes is 3 11/16"

PG2002-3

**10<sup>56</sup>**

KNOB BEARING AND TURN PIECE 6/box  
Std. distance between hole is 2 7/16"

PG2003-3

**12<sup>76</sup>**

**BROAD BEVEL PLATE**

Solid Brass Traditional • 10" x 2 3/4"

KNOB BEARING only 12/box  
PG2021-3

**13<sup>03</sup>**

KNOB BEARING AND CYLINDER HOLE 12/box  
Std. distance between holes is 3 11/16"

PG2022-3

**12<sup>35</sup>**

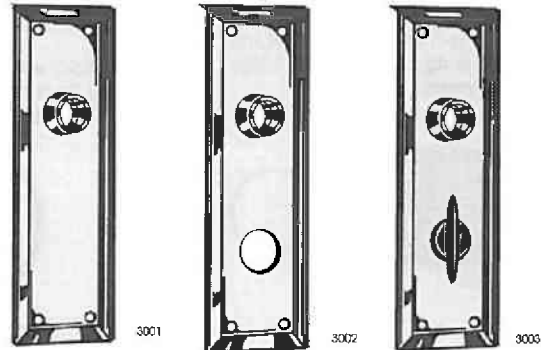

**CORBIN RUSSWIN**

Solid Brass Broad Bevel Plate • 9" x 2-1/2"

KNOB BEARING ONLY 6/box  
PG3001-3

**21<sup>95</sup>**

PG3001-10

**30<sup>18</sup>**

KNOB BEARING AND CYLINDER HOLE 6/box  
PG3002-3

**21<sup>95</sup>**

PG3002-10

**30<sup>18</sup>**

PG3001-26D

**30<sup>18</sup>**

PG3002-26D

**30<sup>18</sup>**

Thumbturns are not solid brass.

KNOB BEARING AND TURN PIECE 6/box

PG3003-3

PG3003-10

PG3003-26D

**19<sup>75</sup>**

**25<sup>38</sup>**

**25<sup>38</sup>**

**MORTISE ENTRANCE LOCKSET**

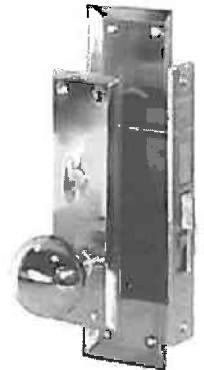

- Surface mounted escutcheon plates-Steel reinforced
- Screw on 2 1/4" Heavy Duty Brass Knobs PG63A-26D
- Two piece 9/32" steel swivel spindle
- Interior trim assembly: 7" x 2 1/4"
- Exterior trim assembly: 10" x 2 3/4"
- Backset: 2 1/2"
- Front: Solid Brass 1 1/16" x 75/8"
- Strike: 4 7/8" x 1 1/4"
- Cylinder: Brass, SE1 keyway w/2 keys
- Polished Brass US3 or Satin Chrome US26D
- Packed 10 per carton - Half LH, Half RH unless requested otherwise

**60<sup>05</sup>**

PG63A-3

**53<sup>66</sup>**

**MARLBOROUGH PLATE** Solid Brass 7-1/2" x 2-1/4"



A heavy duty rolled edge escutcheon, an attractive alternative to the traditional plate. The Marlborough plate has a large knob ferral for heavy duty knobs such as the #3600 knob.

| P/N        | Description                  | Finish         | Price |
|------------|------------------------------|----------------|-------|
| PG4001-3   | Knob Bearing Only            | Polished Brass | 21.95 |
| PG4001-10  | Knob Bearing Only            | Satin Bronze   | 30.18 |
| PG4001-26D | Knob Bearing Only            | Satin Chrome   | 30.18 |
| PG4002-3   | Knob Bearing & Cylinder Hole | Polished Brass | 21.95 |
| PG4002-10  | Knob Bearing & Cylinder Hole | Satin Bronze   | 30.18 |
| PG4002-26D | Knob Bearing & Cylinder Hole | Satin Chrome   | 30.18 |
| PG4003-3   | Knob Bearing & Turn Piece    | Polished Brass | 24.69 |
| PG4003-10  | Knob Bearing & Turn Piece    | Satin Bronze   | 32.92 |
| PG4003-26D | Knob Bearing & Turn Piece    | Satin Chrome   | 32.92 |

**MARKS HARDWARE MORTISE LOCK TRIM**

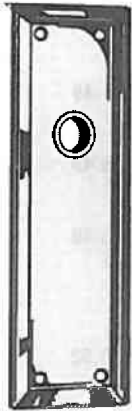

M2001  
M2021

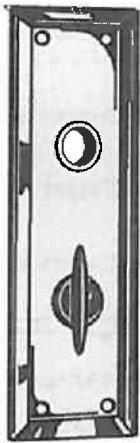

M2003

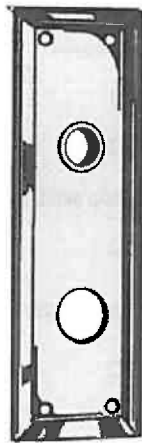

M2022

**KNOB BEARING ONLY 10" x 2-3/4"**  
 Replaces Marks P/N A9280  
 Packed 12pcs/box

PGM2021-3 Polished Brass 13.03

**KNOB BEARING & CYLINDER HOLE 10" x 2-3/4"**  
 Replaces Marks P/N A9281  
 Packed 12pcs/box

PGM2022-26D Satin Chrome 21.26  
 PGM2022-3 Polished Brass 12.35

**KNOB BEARING ONLY 7" x 2-1/4"**  
 Replaces Marks P/N A9261  
 Packed 12pcs/box

PGM2001-26D Satin Chrome 17.15  
 PGM2001-3 Polished Brass 9.33

**KNOB BEARING & TURN PIECE 7" x 2-1/4"**  
 Replaces Marks P/N A9262  
 Packed 6pcs/box

PGM2003-26D Satin Chrome 21.26  
 PGM2003-3 Polished Brass 12.76

**STEP DOWN DOOR HOLDER**

5 1/8" pressure zamac casting. Poly bagged with screws.  
 Packed 10 pcs./box.



PG4482BP Brass Plate 7.54  
 PG4482-26D Satin Chrome 7.54

**REPLACEMENT DOOR KNOBS**

**Solid brass, 2-1/4" replacement knob set.**  
 Double set screws and supplied with 3-1/2" straight spindle. Packed one pair in a display box. Standard thread is 20 TPI.

PG2600-26 Polished Chrome 31.55  
 PG2600-26D Satin Chrome 26.75  
 PG2600-3 Polished Brass 14.49

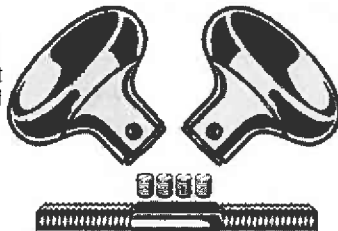

**Solid brass pinned knob set, Lockwood**

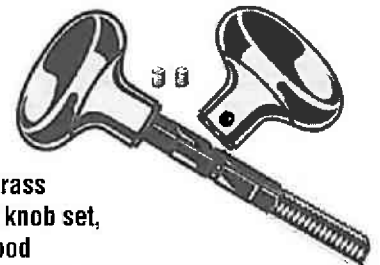

Outside standard duty knob prepinned to swivel spindle for 1-3/4" door with two 3/8" solid centers (3/8" x 3/8"). Inside knob threaded 18 TPI with double set screws. Packed one pair per box.

PG2600LP-10 Satin Bronze 31.55

**REPLACEMENT DOOR KNOB ROSES - SOLID BRASS**

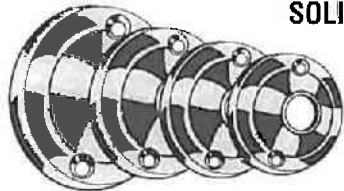

Packaged one pair per poly bag with header for hanging.

| P/N       | Diameter | Finish         | Price |
|-----------|----------|----------------|-------|
| PG205-3   | 2"       | Polished Brass | 5.49  |
| PG206-26D | 2-1/4"   | Satin Chrome   | 8.92  |
| PG206-3   | 2-1/4"   | Polished Brass | 5.49  |
| PG207-3   | 2-1/2"   | Polished Brass | 6.86  |
| PG208-26D | 3"       | Satin Chrome   | 11.25 |
| PG208-3   | 3"       | Polished Brass | 7.27  |

**HERCULITE LOCK**



Square Bolt

PG4255SQ  
**9877**



Round Bolt

PG4255RD  
**9877**

- Equal to Russwin S4255
- All bronze construction
- Square or round bolt
- Supplied with two mounting brackets

**THRU-BOLTED KNOB/ROSE ASSEMBLY**



With spring loaded spindle. Replaces Marks Hardware P/N K9220. Solid brass, M2600, 2 1/4" knobs, preassembled to roses.

PGK6220-3 Brass 21.94  
 PGK6220-26D Satin Chrome 27.43

### REPLACEMENT STEEL SPINDLES 20TPI



**PG44-20-3 1/2** 1.37  
3 1/2" long, 9/32" square

**PG44-20-4** 1.51  
4" long, 9/32" square

**PG44-20-5** 1.78  
5" long, 9/32" square

**PG44-20-6** 3.43  
6" long, 9/32" square



**PG45-20-R** 2.88  
4 3/4" long, 9/32" square. Two 3/8" removable centers.



**PG45-20-S** 8.23  
4 3/4" long, 9/32" square. Two 3/8" solid centers.

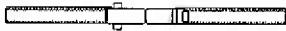

**PG45-20-P** 2.47  
4 3/4" long, 9/32" square. With stop pin.



**PG45-20** 5.49  
4 3/4" long, 9/32" square.



**PG45-20-SPH** 8.23  
4 3/4" long, 9/32" square. Two 3/8" solid centers. Three pin holes one side.

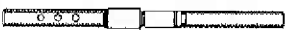

**PG45-20-1/2SPH** 8.92  
4 3/4" long, 9/32" square. One 3/8" solid center. Three pin holes one side.



**PG45-20-RPH** 6.86  
4 3/4" long, 9/32" square. Two 3/8" removable centers. Three pin holes one side.



**PG45-20-C** 7.54  
4 3/4" long, 9/32" square. One 3/8" solid center.

### REPLACEMENT STEEL SPINDLES RUSSWIN/CORBIN - 20TPI



**PG44-20-4** 1.51  
4" long, 9/32" square. Corbin #20

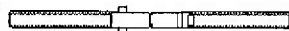

**PG45-20-P** 2.47  
4 3/4" long, 9/32" square. With stop pin. Corbin #21



**PG45-20-C** 7.54  
4 3/4" long, 9/32" square. One 3/8" solid center. Corbin #22



**PG45-20-32** 8.92  
4 3/4" long, 9/32" square. 3/8" solid center one side, 6 pin holes one side. Corbin #32

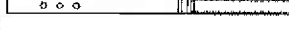

**PG44-20-4PH** 5.49  
4 3/4" long, 9/32" square. 3 pin holes one side. Corbin #30

### REPLACEMENT STEEL SPINDLES LOCKWOOD - 18TPI

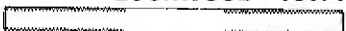

**PG44-18-4** 5.49  
4" long, 9/32" square

**PG44-18-4 1/2** 5.49  
4 1/2" long, 9/32" square. Lockwood #276A

**PG44-18-5** 5.49  
5" long, 9/32" square



**PG45-18-S** 8.92  
4 3/4" long, 9/32" square. Two 3/8" solid centers. Lockwood #293



**PG45-18-SPH** 8.92  
4 3/4" long, 9/32" square. Two 3/8" solid centers, 3 pin holes one side.



**PG45-18-R** 8.92  
4 3/4" long, 9/32" square. Two 3/8" removable centers.



**PG45-18-NTP** 8.92  
4 3/4" long, 9/32" square. With stop notch. With tapped holes: 10-24.

### REPLACEMENT STEEL SPINDLES SARGENT - 16TPI

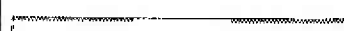

**PG44-16-4** 5.49  
4" long, 9/32" square. Sargent #1632-4

**PG44-16-5** 5.49  
5" long, 9/32" square. Sargent #1632-5

**PG44-16-6** 5.49  
6" long, 9/32" square. Sargent #1632-6

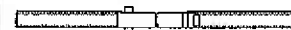

**PG45-16-P** 8.92  
4 3/4" long, 9/32" square. With stop pin.



**PG45-16-S** 8.92  
4 3/4" long, 9/32" square. Two 3/8" solid centers. Sargent #1635.



**PG45-16** 6.17  
4 3/4" long, 9/32" square.

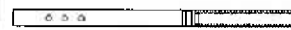

**PG45-16-PH** 8.92  
4 3/4" long, 9/32" square. 3 pin holes one side.



**PG45-16-SPH** 8.92  
4 3/4" long, 9/32" square. Two 3/8" solid centers. 3 pin holes one side.

### SECTIONAL SPINDLES

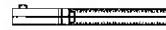

**PG46-20-2 5/8** 3.57  
2 5/8" long, 9/32" square. 20 TPI. Two piece sectional spindle.

**PG46-20-3 1/2** 8.23  
3 1/2" long, 9/32" square. 20 TPI. Two piece sectional spindle.

**PG46-16-2 5/8** 8.23  
2 5/8" long, 9/32" square. 16 TPI. Two piece sectional spindle. For Sargent.

**HEAVY DUTY SPINDLES**  
**3/8" SQUARE x 5" LONG**



**PG44HD** 6.17  
Unthreaded straight spindle, 3/8" square x 5" long.



**PG44HD-TP** 8.92  
Unthreaded straight spindle, 3/8" square x 5" long. With 10-24 tapped holes.



**PG44HD-20** 8.92  
20 TPI straight spindle, 3/8" square x 5" long.



**PG44HD-20-TP** 12.48  
20 TPI straight spindle, 3/8" square x 5" long. With 10-24 tapped holes.



**PG45HD** 8.92  
Unthreaded swivel spindle, 3/8" square x 5" long.



**PG45HD-TP** 10.97  
Unthreaded swivel spindle, 3/8" square x 5" long. With 10-24 tapped holes.



**PG45HD-20** 11.66  
20 TPI swivel spindle, 3/8" square x 5" long.



**PG45HD-20-TP** 15.09  
20 TPI swivel spindle, 3/8" square x 5" long. With 10-24 tapped holes.

**PG2638-3** 32.92  
Solid brass, 2-1/4" knob set is tapped 1/2-20 TPI for use with the as. Knobs have a solid brass gth.



**PG45HD-16** 11.66  
16 TPI swivel spindle, 3/8" square x 5" long. For Sargent.



**SPINDLE ASSORTMENT KITS**

**THE MOST POPULAR SPINDLES ARE NOW AVAILABLE IN A STURDY RE-FILLABLE POLYPROPYLENE BOX IN TWO DIFFERENT ASSORTMENTS**

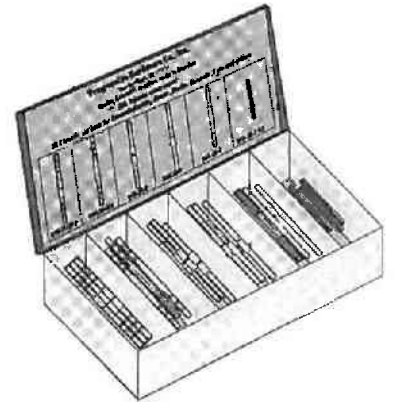

**#20 ASSORTMENT - FOR ALL 20 TPI KNOBS (RUSSWIN/COBFIN, MARKS, ARROW, NORWALK, YALE, ETC.)**

- 6 45-20-S swivel spindle with 3/8" solid centers
- 6 45-20-P swivel spindle with stop pin
- 6 44-20-4 straight spindle
- 6 44-20-4TP straight spindle with tapped holes
- 6 45-20-RTP universal swivel spindle
- 6 46-20-2 5/8 sectional spindle

**PG20**  
**189<sup>30</sup>**

**#1618 ASSORTMENT - FOR ALL 16 TPI (SARGENT) AND 18 TPI (LOCKWOOD) KNOBS.**

- 6 44-16-5 SGT #1632-5 straight spindle
- 6 45-16-S SGT #1635 swivel spindle with 3/8" x 3/8" centers
- 6 46-16 SGT sectional spindle
- 6 44-18-4 1/2 Lockwood #276A straight spindle
- 6 45-18-S Lockwood #293 swivel spindle with 3/8" x 3/8" centers
- 6 46-18 Lockwood sectional spindle

**PG1618**  
**290<sup>81</sup>**

**THE DOOR GUARDIAN - for in-swinging doors**  
**No Exposed Mounting Hardware. Door angle mounted with concealed welded studs. Frame mounting screws are covered when door is locked.**  
**Reversible for left or right hand. Drill template provided.**

| P/N            | Description           | Finish        | Price |
|----------------|-----------------------|---------------|-------|
| PGDG13KB/GP    | 13" w/knob cut-out    | Gold lacquer  | 24.69 |
| PGDG13KB/BLK   | 13" w/knob cut-out    | Black lacquer | 24.69 |
| PGDG13MORT/GP  | 13" w/mortise cut-out | Gold lacquer  | 24.69 |
| PGDG13MORT/BLK | 13" w/mortise cut-out | Black lacquer | 24.69 |
| PGDG13UN/GP    | 13" w/no cut-out      | Gold lacquer  | 24.69 |
| PGDG13UN/BLK   | 13" w/no cut-out      | Black lacquer | 24.69 |
| PGDG13MED/BLK  | 13" w/Medeco cut-out  | Black lacquer | 24.69 |
| PGDG13MED/GP   | 13" w/Medeco cut-out  | Gold lacquer  | 24.69 |

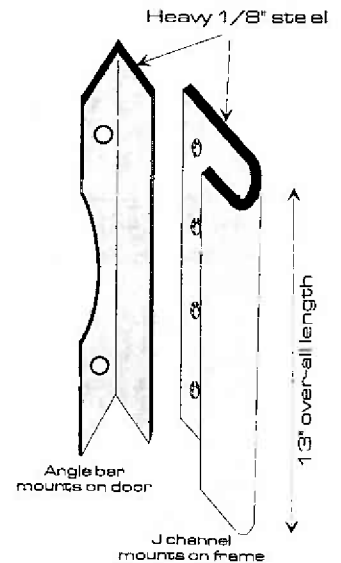

**Also available in 30" & 90" size**

### OVAL PLATE WITH BIT KEY HOLE

1 3/4" x 1 1/8" oval escutcheon.  
Packaged two plates/poly bag

Priced per pair

**PG75-3** Polished Brass 5.21  
**PG75-26D** Satin Chrome 6.17



### SOLID BRASS KEY TAGS

| P/N    | Dimensions    | Approx. Pcs./lb | Price/lb |
|--------|---------------|-----------------|----------|
| PG05-L | 15/16" x .040 | 115 pcs/lb      | 27.16    |
| PG06-T | 1" x .025     | 149 pcs/lb      | 27.16    |
| PG07   | 1 1/4" x .040 | 60 pcs/lb       | 27.16    |
| PG011  | 1 3/8" x .060 | 38 pcs/lb       | 27.11    |

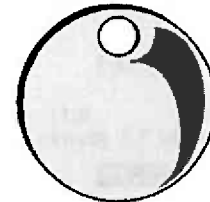

### OVAL PLATE WITH THUMB TURN

1 3/4" X 1 1/8" oval escutcheon. Turn has 3/16" square tail.  
Packaged one per poly bag

**PG76-3** Polished Brass 6.17  
**PG76-26D** Satin Chrome 9.60

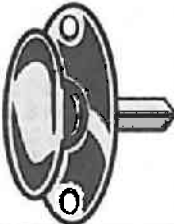

### PUSH & PULL PLATES

**1001:** 3 1/2" x 15" push plate. Full 16 guage (.062") metal. Individually poly bagged. Packed 4/box.

**1012:** 3 1/2" x 15" push plate with solid brass or aluminum pull with 4 7/8" center to center. Packed with mounting screws and handle thru bolts. Individually poly bagged. Packed 2/box.

| P/N       | Descrip.   | Material        | Price |
|-----------|------------|-----------------|-------|
| PG1001-3  | Push Plate | Solid Brass     | 16.46 |
| PG1001-32 | Push Plate | Stainless Steel | 16.46 |
| PG1001-28 | Push Plate | Aluminum        | 9.88  |
| PG1012-3  | Pull Plate | Solid Brass     | 41.15 |
| PG1012-32 | Pull Plate | Stainless Steel | 30.04 |
| PG1012-28 | Pull Plate | Aluminum        | 24.55 |



### ROUND PLATE WITH THUMB TURN

2 1/4" round escutcheon. Turn piece has 3/16" square tail.  
Packaged one per poly bag

**PG77-3** 6.86  
Polished Brass

**PG77-26D** 10.29  
Satin Chrome

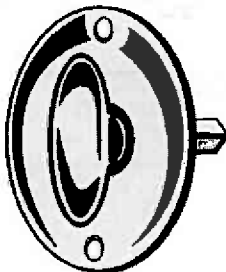

### DUMMY CYLINDER

Die cast face with steel back plate. Covers standard cylinder hole.  
One per poly bag.

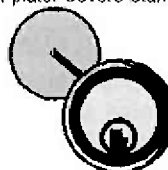

**PG195BP** Brass Plate 2.06  
**PG195CP** Satin Chrome Plate 2.06

### FILLER PLATES

#### FRAME FILLER PLATE - A.S.A. CUT-OUT

4 7/8" x 1 1/4"  
Steel, prime coat  
Packaged one per poly bag.

**PG74FP**  
**247**



#### FRAME FILLER PLATE

2 3/4" x 1 1/8"  
Steel, prime coat.  
Packaged one per poly bag.

**PG72FP**  
**247**



#### DOOR FILLER PLATE

2 1/4" x 1 1/8"  
Steel, prime coat.  
Packaged one per poly bag.

**PG73FP**  
**233**



### TUBULAR PASSAGE LATCH

2 3/8" backset plain passage latch. Accepts standard 9/32" square spindle.

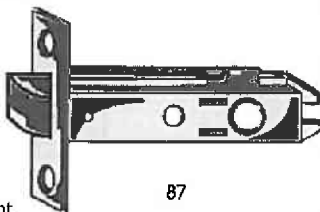

Brass plated front  
Packed 12/box

**PG87**  
**721**

### SCAR PLATES

3/16" OD with 1 1/4" hole  
Packed one per poly bag

**PG198-3** Solid Brass 3.70  
**PG198-32** Stainless Steel 3.70



3 1/16" x 1 3/4" OD with 1 1/4" hole  
Packed one per poly bag

**PG199-3** Solid Brass 3.70  
**PG199-32** Stainless Steel 3.70



**MORTISE CYLINDER GUARD PLATE**

**4" x 10"**

Can either replace or go over existing trim (will cover up to 8" escutcheon). 1/4" high cylinder bubble. Supplied with carriage bolts, cap nuts and washers. Extra heavy gauge wrought steel. *Brass on steel finish*

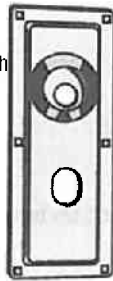

PG1044BP

**13<sup>03</sup>**

**ADJUSTABLE MORTISE CYLINDER GUARD - 3" x 11"**

Cylinder guard replaces existing trim. Adjustable rose allows this plate to fit virtually any mortise lock. Raised bubble covers mortise cylinder and prevents wrenching of cylinder. Supplied with four carriage bolts and sex bolts. Extra heavy gauge wrought steel. *Brass on steel finish*



PG1066BP

**14<sup>40</sup>**

**REPLACEMENT STRIKES**

**2 1/4" full lip strike**

PG73BP Steel, brass plate 2.06



**2 3/4" x 1 1/8" T-strike**

PG72-3 Solid brass 3.70  
 PG72-32 Stainless Steel 3.70



**4 7/8" x 1 1/4"**

**Mortise A. S. A.**

PG74-3 Solid brass 7.13  
 PG74-26D Satin Chrome 7.13  
 PG74BP Brass Plate 3.43



**4 7/8" x 1 1/4"**

**Standard A. S. A.**

PG71-3 Solid brass 7.13  
 PG71-26D Satin Chrome 7.13

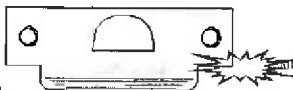

**LATCH PROTECTORS FOR OUTSWINGING DOORS**

**3" x 11" LATCH GUARD**

Massive wrought steel or solid brass fits key-in-knob or mortise locks. Complete with carriage bolts, acorn nuts and washers. Individually poly bagged with hanging header.

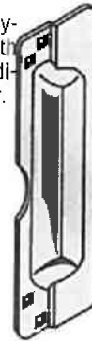

| P/N      | Material | Finish    | Price |
|----------|----------|-----------|-------|
| PG1033BP | Steel    | Brass     | 10.29 |
| PG1033DU | Steel    | Duranodic | 8.92  |
| PG1033SL | Steel    | Silver    | 8.92  |

**2 5/8" x 12" OFFSET LATCH GUARD**

Heavy 1/8" steel. 1/4" offset, 1 1/8" backset, 1 7/16" cylinder hole. Protects latch or bolt. Reversible. Supplied with carriage bolts, acorn nuts and washers.



| P/N          | Material | Finish    | Price |
|--------------|----------|-----------|-------|
| PG1077-DU    | Steel    | Duranodic | 10.97 |
| PG1077-SL    | Steel    | Silver    | 10.97 |
| *PG1077-WODU | Steel    | Duranodic | 10.97 |
| *PG1077-WOSL | Steel    | Silver    | 10.97 |

\*w/o hole

**2 5/8" x 7" OFFSET LATCH GUARD**

Heavy 1/8" steel. 1/4" offset, 1 1/8" backset, 1 7/16" cylinder hole. Protects latch or bolt. Reversible. Supplied with carriage bolts, acorn nuts and washers.

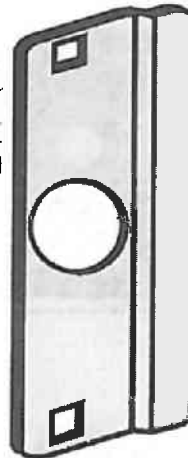

| P/N          | Material | Finish    | Price |
|--------------|----------|-----------|-------|
| PG1088-DU    | Steel    | Duranodic | 8.92  |
| PG1088-SL    | Steel    | Silver    | 8.92  |
| *PG1088-WODU | Steel    | Duranodic | 8.92  |
| *PG1088-WOSL | Steel    | Silver    | 8.92  |

\*w/o hole

**2 5/8" x 7" OFFSET LATCH GUARD**

This plate has a cutout for up to 3 1/2" roses. 1/4" offset. For deadbolt or key-in-knob locksets.

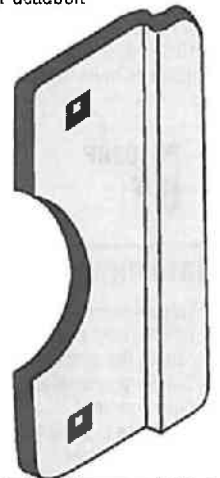

| P/N       | Material | Finish    | Price |
|-----------|----------|-----------|-------|
| PG1099-DU | Steel    | Duranodic | 8.92  |
| PG1099-SL | Steel    | Silver    | 8.92  |

**EXIT DEVICE, UL LISTED**

- Available in aluminum and duranodic painted finishes
- Dogging feature is standard
- Includes all mounting fasteners, strike and filler plates to retrofit almost every existing device
- High visibility black, non-slip, textured touch bar
- Internal activator lever made of cast stainless steel
- Cast stainless steel bolt & deadlatch

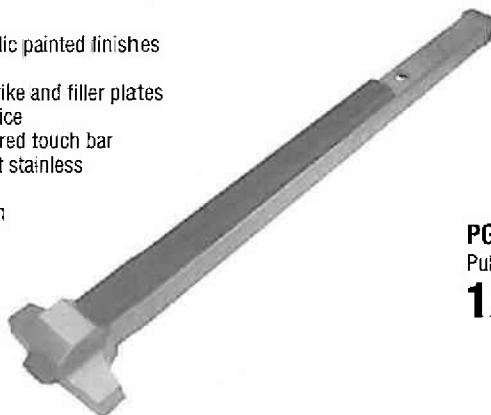

**PG560PC-AL**  
Pull with cylinder hole & sex bolts  
**123<sup>5</sup>**



**PG560P-AL**  
Pull w/o cylinder hole, with sex bolts  
**123<sup>5</sup>**

| P/N       | Description                  | Length | Finish    | Price  |
|-----------|------------------------------|--------|-----------|--------|
| PG560AL-3 | Reversible Device, Exit Only | 36"    | Aluminum  | 131.08 |
| PG560AL-4 | Reversible Device, Exit Only | 48"    | Aluminum  | 144.80 |
| PG560DU-3 | Reversible Device, Exit Only | 36"    | Duranodic | 131.08 |
| PG560DU-4 | Reversible Device, Exit Only | 48"    | Duranodic | 144.80 |



**PG560LH-26D**  
Lever Handle, Standard Duty  
**71<sup>33</sup>**



**PG560BK-32**  
Ball Knob, Standard Duty  
**68<sup>59</sup>**

**103BP RIM LOCK CYLINDER GUARD**

- 5 7/8" X 3" X .090" wrought steel
- Brass plated
- 3/16" center rise for cylinder
- 13/16" diameter key hole
- Includes bolts, nuts, washers

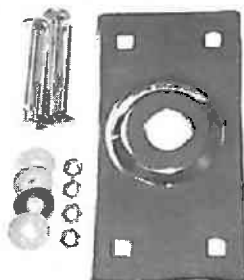

**PG103BP**  
**6<sup>17</sup>**

**67 RISING SHIM**

For shimming strike used with Jimmy Proof drop bolt locks

- 1" x 4 1/8" x 16 gauge
- Steel, zinc plated
- Packed 10 pcs per poly bag



**PG67**  
**82¢ each**

**1010 UNIVERSAL MORTISE LATCH**

- Latches reversible for left or right handed doors
- Will fit most existing installations by simply cutting the over-size faceplate
- Solid brass latch and spindle hub
- Cast iron base
- Over-size front is 1" x 6" with four mounting holes
- Includes multi-holed 6" security strike

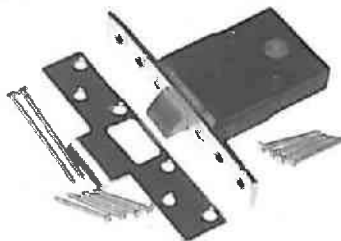

**PG1010**  
**71<sup>33</sup>**

**R1000 DROP BOLT FOR REVOLVING DOORS & OTHER APPLICATIONS**

- Case is 5 7/8" x 1 3/4" x 1" ingot aluminum
- Stainless steel bolt is 5/8" round
- Bolt protrudes 1 9/16"
- Turn key 900 and bolt drops
- Cylinder w/2 keys included



**PGR1000-DU** Duranodic **104.25**  
**PGR1000-AL** Aluminum **104.25**

**DOUBLE BAR LOCK**

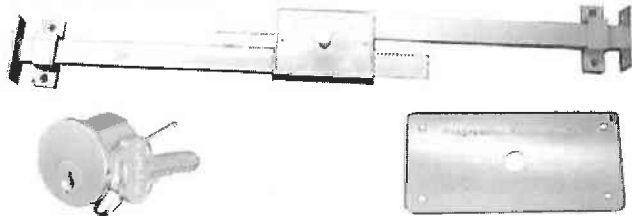

| P/N         | Fits Door                | List   |
|-------------|--------------------------|--------|
| PGDBL-01-32 | 30"-34"                  | 175.28 |
| PGDBL-01-36 | 34"-38"                  | 175.28 |
| PGDBL-01-42 | 40"-44"                  | 175.28 |
| PGDBL-01-48 | 46"-50"                  | 175.28 |
| PGDBL-BRKT  | Bracket for inswing door | 13.72  |
| PGDBL-TK    | Repl. Knob/Gear Assy     | 22.63  |

**K700 SERIES DOOR CLOSERS**

- UL Listed
- Adjustable latching and closing speeds
- Full rack and pinion for 100% control
- Cast aluminum body - non-handed
- Surface mounted for regular, top jamb or parallel arm (with optional bracket)
- For use on trimline aluminum, wood or hollow metal doors
- 24 hour salt spray tested



| P/N         | Description                   | Finish    | Price |
|-------------|-------------------------------|-----------|-------|
| PGK720-AL   | Light to med. duty            | Aluminum  | 59.45 |
| PGK730-AL   | Medium Duty                   | Aluminum  | 62.50 |
| PGK730-DU   | Medium Duty                   | Duronodic | 62.50 |
| PGK730BC-AL | Medium Duty w/back-check      | Aluminum  | 65.54 |
| PGK740-AL   | Medium to Heavy Duty          | Aluminum  | 65.54 |
| PGK740-DU   | Medium to Heavy Duty          | Duronodic | 65.54 |
| PGK740BC-AL | Med. to Hvy Duty w/back-check | Aluminum  | 69.36 |
| PGK740BC-DU | Med. to Hvy Duty w/back-check | Duronodic | 69.36 |
| PGK750-AL   | Heavy Duty                    | Aluminum  | 69.36 |
| PGK750-DU   | Heavy Duty                    | Duronodic | 69.36 |

**FOX POLICE LOCK CYLINDER**

- Solid brass bar stock cylinder with round tail
- Russwin 1011 keyway
- Two nickel silver keys
- Includes cylinder ring and connecting screws
- Satin Brass finish



PG160FPL  
**24<sup>69</sup>**

**JIMMY-PROOF VERTICAL DEADBOLT**

- Solid bronze case-bolt-strike
- Hardened drill point screws
- Shutter guard for extra security
- Solid brass cylinder, SE1 keyway, 5 pin w/recessed cylinder collar
- Flat strike standard

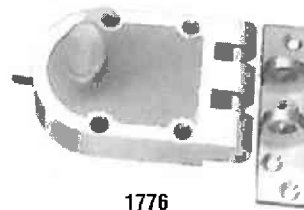

1776



1776AS

| P/N       | Finish          | Strike | Price |
|-----------|-----------------|--------|-------|
| PG1776-10 | Satin Bronze    | Flat   | 53.34 |
| PG1776-26 | Polished Chrome | Flat   | 64.00 |
| PG1776-3  | Polished Brass  | Flat   | 60.96 |
| PG1786-10 | Satin Bronze    | Angle  | 54.87 |
| PG1786-26 | Polished Chrome | Angle  | 65.54 |
| PG1786-3  | Polished Brass  | Angle  | 62.50 |

**Angle Strikes**

|             |                 |       |
|-------------|-----------------|-------|
| PG1776AS-10 | Satin Bronze    | 10.97 |
| PG1776AS-26 | Polished Chrome | 10.97 |
| PG1776AS-3  | Polished Brass  | 10.97 |

**DOOR INTERVIEWER WITH KNOCKER**

A low cost interviewer and knocker that will provide security with functionality. 3 1/2" x 4 1/2" exterior plate is a high pressure zamac casting with an attractive polished brass finish. The glass lens provides a minimum of 1600 of unobstructed view of the area outside the door.

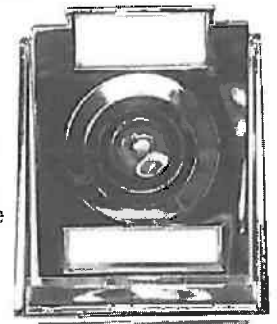

Two slots are available for insertion of an apartment number and tenant name. The interior side of the viewer has a security cover that remains closed unless manually opened. The exterior plate cannot be turned by vandals if properly installed.

PG121-K  
**20<sup>58</sup>**

**ROLL DOWN GATE PIN**

Roll down gate locking pin. Wrought iron pin with welded head 1/2" round locking pin. 4 3/4" over-all length.



Roll down gate pin

PG1875  
**7<sup>27</sup>**

**HEAVY DUTY CHAIN DOOR GUARD**



- Solid brass mounting plates
- Riveted steel roller chain
- Blister carded for secure and easy selling

PG100-3  
**19<sup>20</sup>**